

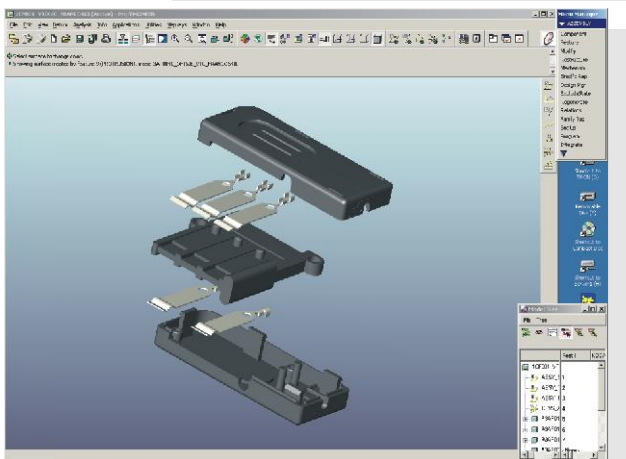

# Catalogue LE-TEHNIKA ALL FOR TELEPHONE

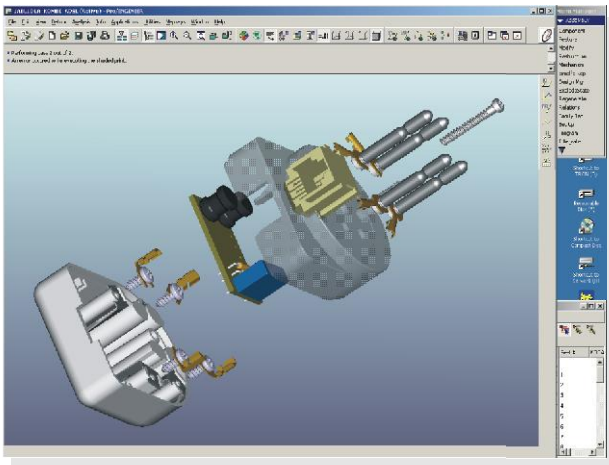



## CERTIFICATE



The Certification Body  
of TÜV SÜD Management Service GmbH  
certifies that

**Le-Tehnika d.o.o.**  
Suceva 27  
SI - 4000 Kranj  
with location  
Le-Tehnika d.o.o.  
Ljubljanska 140  
SI - 2000 Maribor

has established and applies a  
Quality and Environmental Management System  
for the following scope of application:

**Development, Production, Service, Sale, Representation and Advising  
in the Fields of Telecommunication, Hydraulics, Pneumatics and  
Cryogenics**

Performance of audits (Report-No. 70012469)  
has furnished proof that the requirements under:

**ISO 9001: 2000  
ISO 14001: 2004**

are fulfilled. This certificate is valid until 2009-12-17  
Certificate Registration No. 12 100/104 12866 TMS



*M. Wenzel*  
Munich, 2007-01-03



TÜV SÜD Management Service GmbH • Zertifizierungsstelle • Riederstraße 65 • 80329 München • Germany

We proudly present you our company's catalogue. Here you can find products which have been well received by our clients. While some products from our business scope may be missing here our research and development team is ready to take your personal requests and with the support of our production department convert them into products.

Our accurate quality control system gives our customers full assurance that the products they receive have been examined and handled with maximal care.

LE-TEHNIKA d.o.o.

# Index

	Page:
- Modular wall jacks	2
- Telephone switches	3
- Modular couplers	4
- Euro magic bricks	5
- Modular plugs	6
- PCB modular jacks	7 - 10
- Modular wiring jacks	10 - 12
- Tools	13 - 14
- Cables	15 - 16
- Cable accessories (terminals, sleeves, clips)	16 - 19
- Equiped cables	20
- Handset cords	21
- Quick mounting channels	22
- ISDN	23
- ADSL, MDF splitters	24 - 26
- CAT5e	26
- Surge protectors	27
- Telephone accessories	28,29, 32
- Testing tools	30 - 31
- Universal adapters - Magic boxies	33
- SLO, CRO, BIH, SR, MAC type	34 - 36
- Austrian type	37 - 44
- German type	45 - 52
- Italian type	53 - 54
- Czech and Slovakian type	55
- Hungarian type	56
- Russian, Polish & Bulgarian type	57
- Swiss type	58 - 60
- Belgian type	61
- Holland (Dutch) type	62
- French type	63
- Turkish type	64
- Norwegian & Finnish type	65
- UK type	66 - 67
- Power accessories - Travel power adapter	68

## EURO MODULAR WALL JACK



### ASSEMBLING DATA

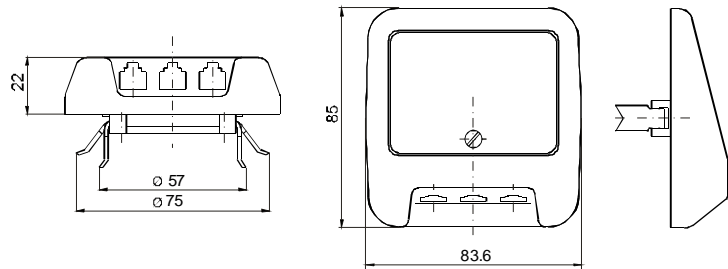

CODE		MODULAR JACK		
Flash mounting	Surface mounting	RJ 11	RJ 11	RJ 11
1 DAA 001	1 DAA 011	—	6/4	—
1 DAA 002	1 DAA 012	6/4	—	6/4
1 DAA 003	1 DAA 013	6/4	6/4	6/4

\* Special order ( other colours possible)

### WIRING DIAGRAM

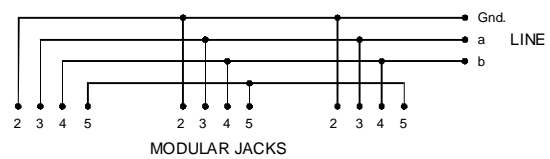

### EACH MODULAR JACK HAS ITS OWN TELEPHONE LINE

CODE		MODULAR JACK		
Flash mounting	Surface mounting	RJ 11	RJ 11	RJ 11
1 DLA 002	1 DLA 012	6/4	—	6/4
1 DLA 003	1 DLA 013	6/4	6/4	6/4

\* Special order ( other colours possible)

\* Special order: each jack has its own tel. line!

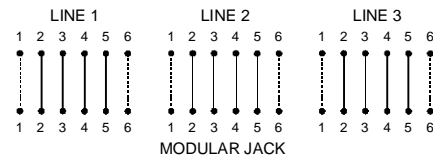

Option: modular jack 6/6, 8/8, 10/10

## SURFACE MOUNTING MODULAR JACK

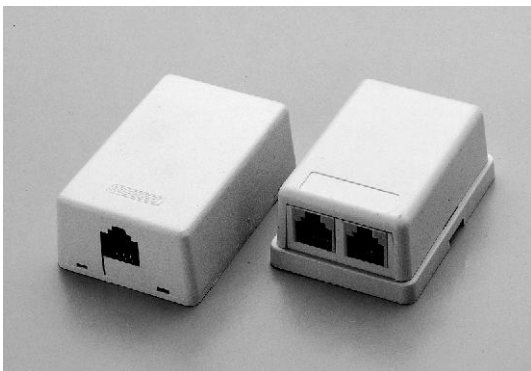

### ASSEMBLING DATA

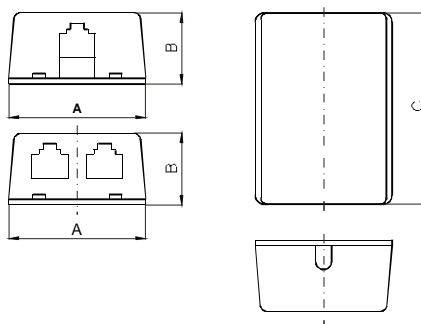

### WIRING DIAGRAM 1DN164

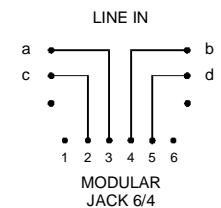

CODE	MODULAR JACK	DIMENSIONS (mm)		
		A	B	C
1 DN 164	6/4	42	24	58
1 DN 188	8/8	56	20.5	56.2
1 DN 264	2x6/4	42.4	24.5	58
1 DN 265	2x6/4*	42.4	24.5	58

\* two different lines

### WIRING DIAGRAM 1DN188 or 1DN264

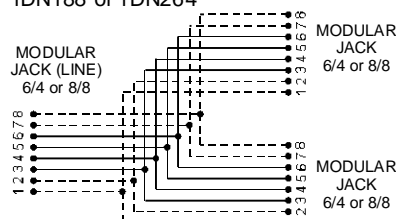

### WIRING DIAGRAM 1DN265

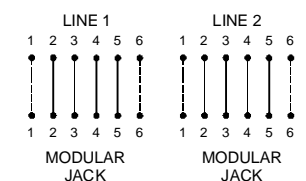

\* Special order: each jack has its own tel. line!

## MOUNTING JACK WITH AUTOMATIC TELEPHONE SWITCH

CODE	Mounting type	Modular jack
1 EDA 003	Flash mounting	3
1 EDA 013	Surface mount.	3

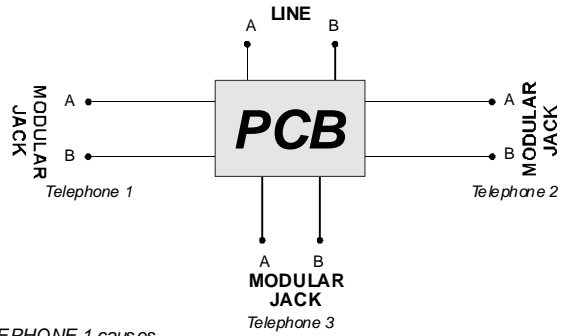

Lifting the handset of TELEPHONE 1 causes blocking of TELEPHONE 2, TELEPHONE 3 and vice - versa.

## MOUNTING JACK WITH MANUAL TELEPHONE SWITCH

CODE	Mounting type
1 DEA 012	Surface mounting
1 DEA 002	Flash mount.

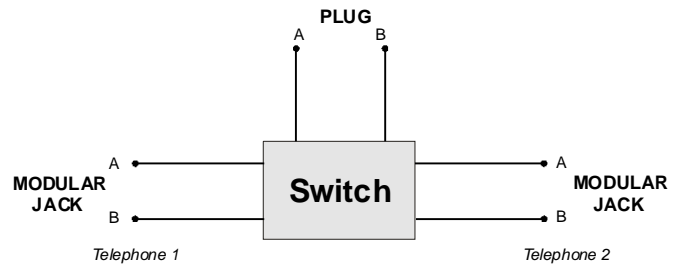

Lifting the handset of TELEPHONE 1 causes blocking of TELEPHONE 2 and vice - versa

# MODULAR COUPLERS



## MODULAR "IN LINE" COUPLER



CODE	MODULAR JACK	DIMENSIONS			WIRING
		A	B	C	
1 AA 025	2 X 6/4	23,7	14,7	36,2	1
1 AA 026	2 X 6/6	23,7	14,7	36,2	1
1 AA 028	2 X 8/8	22,5	16,8	36,8	2
1 AA 028K	2 X 8/8	22,5	16,8	36,8	1
1 AA 033	2 X 8/4	22,5	16,8	36,8	2
1 AA 032	2 X 10/10	22,5	16,8	36,8	2

### ASSEMBLING DATA

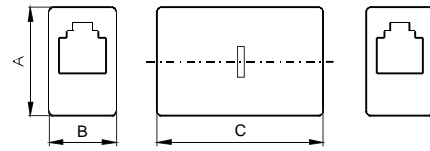

### WIRING DIAGRAM 1

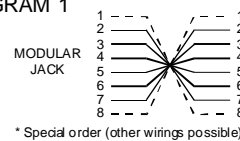

### WIRING DIAGRAM 2

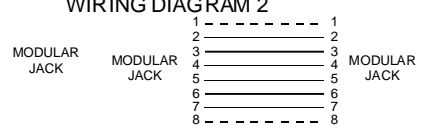

\* Special order (other wirings possible)

## MODULAR DUPLEX "T" COUPLER

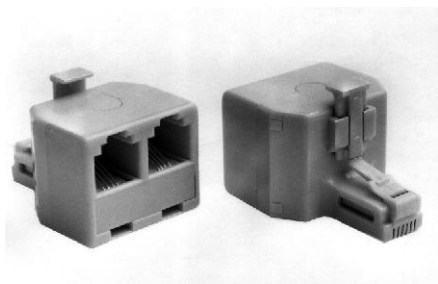

CODE	Modular plug	Modular jack	DIMENSIONS	
			A	B
1 AA 020	1 X 6/4	2 X 6/4	26,5	21,2
1 AA 066	1 X 6/6	2 X 6/6	29,6	23,5
1 AA 038	1 X 8/8	2 X 8/8	29,6	23,5

### ASSEMBLING DATA

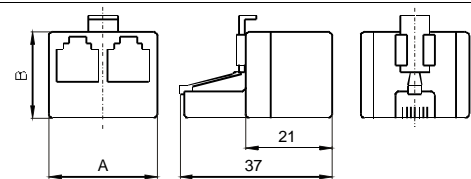

### WIRING DIAGRAM

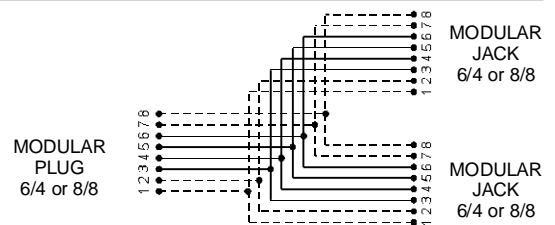

## MODULAR TRIPLEX COUPLER

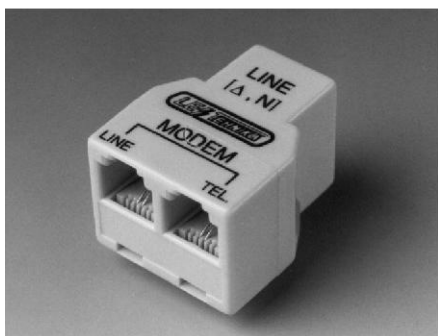
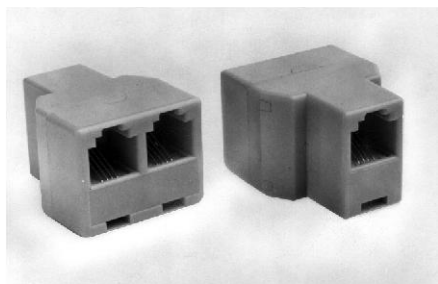

CODE	Modular jack	Wiring diagram	DIMENSIONS	
			A	B
1 AA 021	3 X 6/4	1	26,5	21,2
1 AA 022	1x6/4, 2x6/2	2	26,5	21,2
1 AA 267	3 X 6/6	1	29,5	23,5
1 AA 039	3 X 8/8	1	29,5	23,5
1 AA 041	3 X 8/4	1	29,5	23,5

### ASSEMBLING DATA

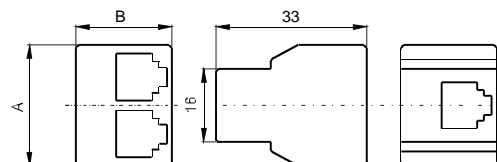

### WIRING DIAGRAM 1

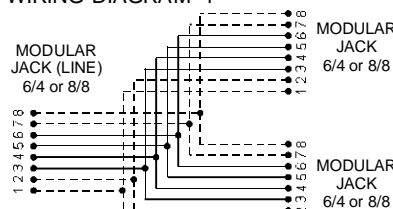

### WIRING DIAGRAM 2

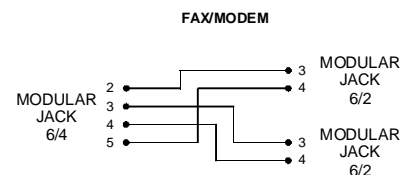

## EURO MAGIC BRICK

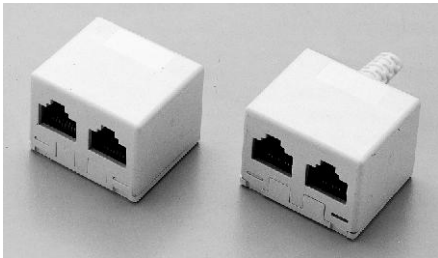
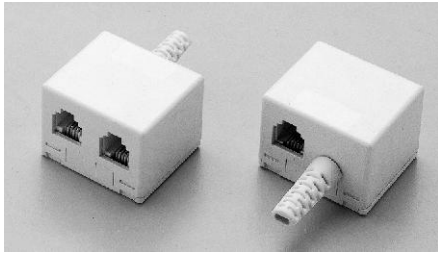

TABLE 1

CHOOSE BACK \ CHOOSE FRONT	L	K	J	I	H	G	F	E	D	C	B	A
A	AL	AK	AJ	AI	AH	AG	AF	AE	AD	AC	AB	AA
B	BL	BK	BJ	BI	BH	BG	BF	BE	BD	BC	BB	
C	CL	CK	CJ	CI	CH	CG	CF	CE	CD	CC		
D	DL	DK	DJ	DI	DH	DG	DF	DE	DD			
E	EL	EK	EJ	EI	EH	EG	EF	EE				
F	FL	FK	FJ	FI	FH	FG	FF					
G	GL	GK	GJ	GI	GH	GG						
H	HL	HK	HJ	HI	HH							
I	IL	IK	IJ	II								
J	JL	JK	JJ									
K	KL	KK										
L	LL											

TABLE 2 (Top side)

RIGHT \ LEFT	Empty
Empty	0 0

TABLE 3 (No. of loaded contacts)

USE POSSIBLE	4	6	8	10
4	UX			
6	VX	VZ		
8	ZX	ZZ	ZV	
10	XX	XZ	XV	XU

COLOUR

White = B
Black = C

### ASSEMBLING DATA

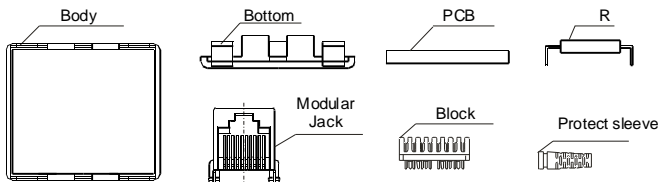

### CHOOSE CODE FOR EURO MAGIC BRICK

1 Z D D 0 0 V X 0 1 B

Code system

Table 1 (choose letter - left and right)

Table 2 (choose number - left and right)

Table 3 (choose letter for contacts)

Wirings (choose wiring diagram)

Colour (B = white C = black)

WIRING DIAGRAM 1 (without 2 x 100 R)  
WIRING DIAGRAM 2 (with 2 x 100 R)

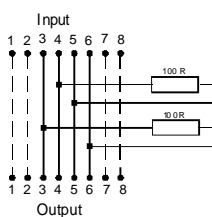

WIRING DIAGRAM 3 (without 2 x 100 R)  
WIRING DIAGRAM 4 (with 2 x 100 R)

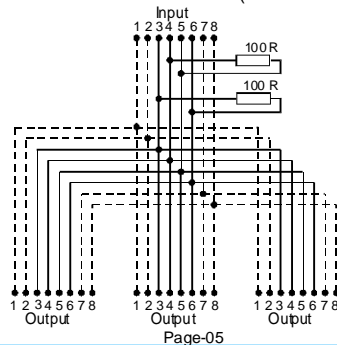

WIRING DIAGRAM 5 (without 2 x 100 R)  
WIRING DIAGRAM 6 (with 2 x 100 R)

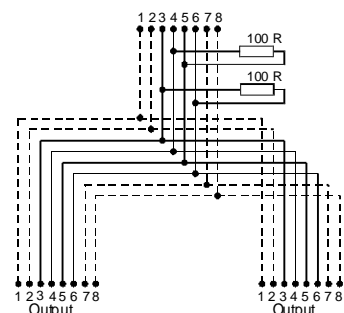

## TECHNICAL SPECIFICATIONS

### BASIC FEATURES :

- \* Corresponds with FCC-68 STYLE JACKS
- \* Contacts can be rearranged
- \* Selective gold plated
- \* To terminate flat oval telephone cord to REA Buletin 345-80, PE 75 and round telephone cable
- \* No need for cable stripping 4, 6, 8 and 10 way loaded or pCableially loaded

### MATERIAL:

- HOUSING:** Polycarbonat UL 94V-2
- CONTACT:** Sn Bronze
- SHIELD:** Phosphor Bronze Alloy - Nickel coated

### ELECTRICAL CHARACTERISTICS:

- Insulation Resistance:** Min 500 MΩ
- Contact Resistance:** Max 20 mΩ
- Dielectric Withstanding Voltage:** 1000 Volts RMS 50 Hz
- Current Rating:** 1,5 A

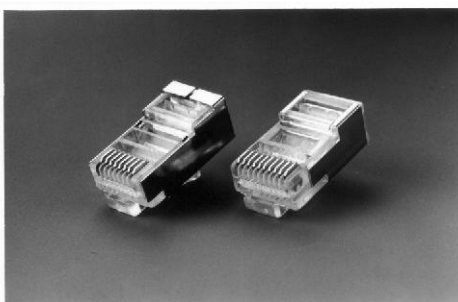
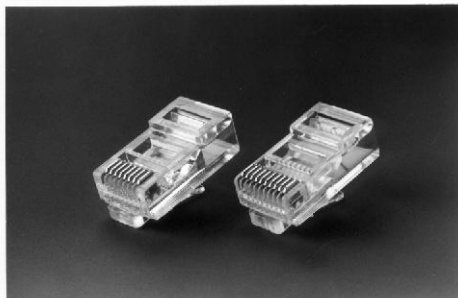
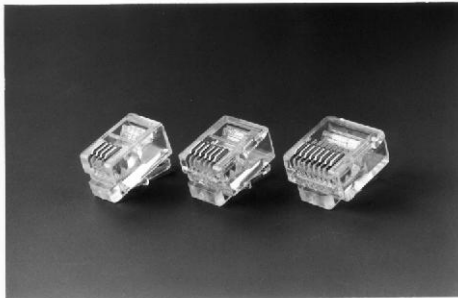

### TRANSPARENT MODULAR PLUGS:

CODE	Possible contacts	Loaded contacts	Type of cable	Dimensions (mm)				
				A	B	C	D	E
2 CA 050	4	4	flat	12,33	3,05	2,54	4,95	7,62
2 CA 062	6	2	flat	12,33	5,08	3,25	6,05	9,65
2 CA 061	6	4	flat	12,33	5,08	3,25	6,05	9,65
2 CA 060	6	6	flat	12,33	5,08	3,25	6,05	9,65
2 CO 062	6	2	round	12,33	5,08	3,25	6,05	9,65
2 CO 064	6	4	round	12,33	5,08	3,25	6,05	9,65
2 CO 066	6	6	round	12,33	5,08	3,25	6,05	9,65
2 CO 088	8	8	round	21,40	7,11	3,25	6,10	11,68
2 CA 070	8	8	flat	21,40	7,11	3,25	6,10	11,68
2 CA 070K	8/Short	8	flat	12,33	7,11	3,25	6,10	11,68
2 CA 074	8	4	flat	21,40	7,11	3,25	6,10	11,68
2 CA 084K	8/Short	4	flat	12,33	7,11	3,25	6,10	11,68
2 CO 070*	8 Shielded	8	flat	21,40	7,11	3,25	6,10	11,68
2 CA 100	10	10	flat	21,40	9,14	3,25	6,10	11,68
2 CA 101	10/Shielded	10	flat	21,40	9,14	3,25	6,10	11,68
2 CA 070T	8	8	hard wire	21,40	9,14	3,25	6,10	11,68
2 CO 6070	8/CAT6/Sh.	8	round	21,40	9,14	3,25	6,10	11,68
2 CO 6088	8/CAT6	8	round	21,40	9,14	3,25	6,10	11,68
2 CA 066	6/DEC	6	flat	12,32	5,08	3,25	6,10	11,68

\* 50μ Inch gold plated

### COLORED MODULAR PLUGS:

Colour	CODE	Poss./Load. contact	Colour	CODE	Poss./Load. contact	Colour	CODE	Poss./Load. contact
Green	2CA060G	6/6	Green	2CA070G	8/8	Green	2CA074G	8/4
Red	2CA060R	6/6	Red	2CA070R	8/8	Red	2CA074R	8/4
Blue	2CA060B	6/6	Blue	2CA070B	8/8	Blue	2CA074B	8/4
Yellow	2CA060Y	6/6	Yellow	2CA070Y	8/8	Yellow	2CA074Y	8/4

### ASSEMBLING DATA

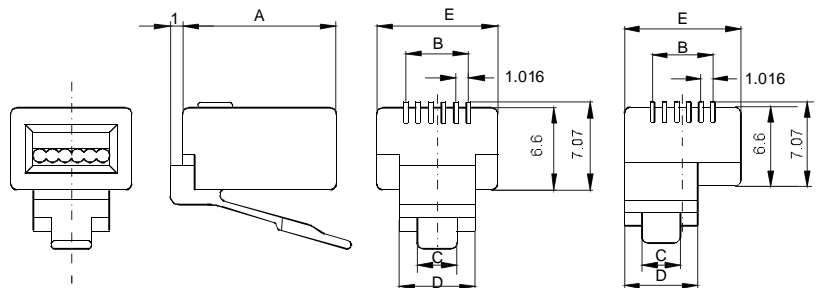

## MODULAR PLUG WITH INSERT

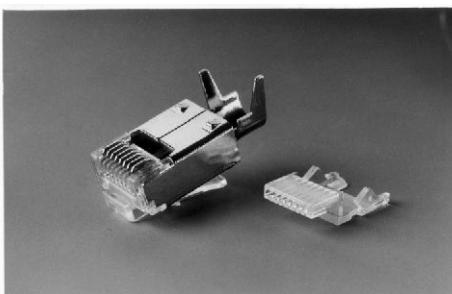

CODE	Possible contacts	Loaded contacts	Type of cable
2 CC 088	8	8	flat

### ASSEMBLING DATA

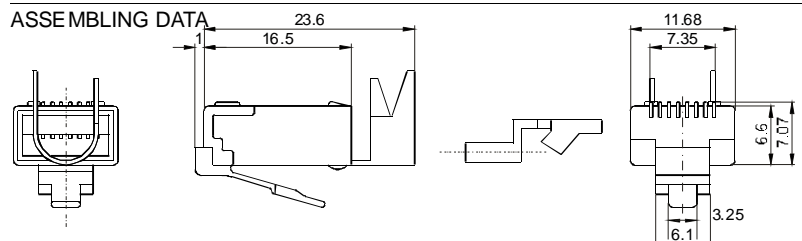



## TECHNICAL SPECIFICATIONS

### BASIC FEATURES :

- Industry compatible
- PCB MOUNTING
- Corresponds with FCC-68 specification

### MATERIAL:

1. HOUSING : UL 94V-0  
Optional: ABS Resin 94V-0
2. CONTACT: 0,45 mm (0,018 inch) Diameter, Phosp or Bronze Alloy

### ELECTRICAL CHARACTERISTICS:

1. Insulation Resistance: Min 10 M Ω
2. Contact Resistance : Max 20 m Ω
3. Dielectric Withstanding Voltage: 1000 Vrms 50 Hz
4. Current Rating: 1,5 A

## MINI LOW PROFILE PCB JACK

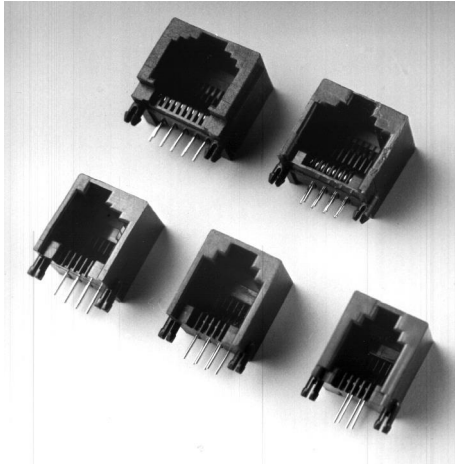

Standard colour : black

CODE	Possible contacts	Loaded contacts	Dimensions (mm)					PCB Layout
			A	B	C	D	E	
2 DD 062	6	2	11,50	12,20	12,00	4,64	4,5	1
2 DD 063	6	3	11,50	12,20	12,00	4,64	4,5	1
2 DD 064	6	4	11,50	12,20	12,00	4,64	4,5	1
2 DD 066	6	6	11,50	12,20	12,00	4,64	4,5	1
2 DD 088	8	8	11,50	14,20	14,00	4,64	4,5	2
2 DD 100	10	10	11,50	14,20	14,00	4,64	4,5	2
2 DC 044	4	4	13,00	10,00	11,00	4,64	5,9	1
2 DC 040	4	4	13,00	12,20	11,00	4,64	5,9	1
2 DC 062	6	2	13,00	12,20	12,00	4,64	5,9	1
2 DC 063	6	3	13,00	12,20	12,00	4,64	5,9	1
2 DC 064	6	4	13,00	12,20	12,00	4,64	5,9	1
2 DC 066	6	6	13,00	12,20	12,00	4,64	5,9	1
2 DC 088	8	8	13,00	15,20	14,90	4,70	5,9	1
2 DC 100	10	10	13,00	15,20	14,90	4,70	5,9	1
2 DC 966	6 DEC	6	13,00	12,20	12,00	4,64	4,5	1

### ASSEMBLING DATA

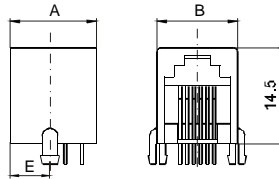

### PCB LAYOUT 1 (Top view)

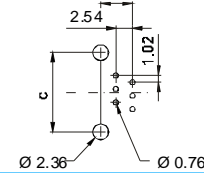

### PCB LAYOUT 2 (Top view)

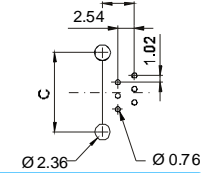

## MINI LOW PROFILE PCB MODULAR JACK - SHIELDED

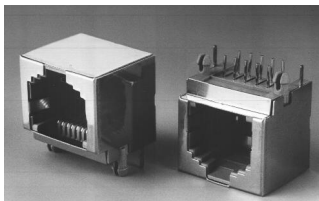

### ASSEMBLING DATA

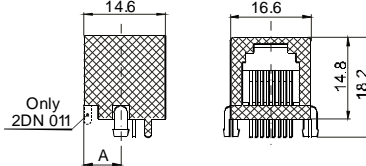

### PCB LAYOUT (Top view 2DF 088)

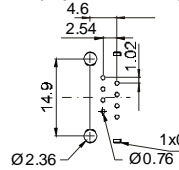

### PCB LAYOUT (Top view 2DFC 088)

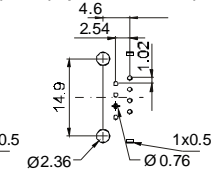

### PCB LAYOUT (Top view 2DN 011)

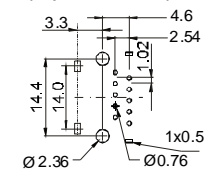

CODE	Possible contacts	Loaded contacts	A
2 DF 088	8	8	6,5
2 DFC 088	8	8	6,5
2 DN 011	10	10	5,85

## PCB MODULAR JACK - with LED indicators

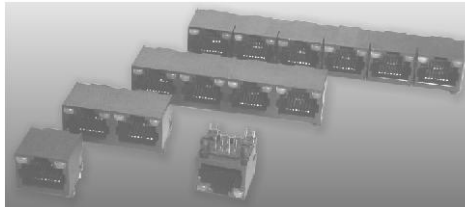

### ASSEMBLING DATA

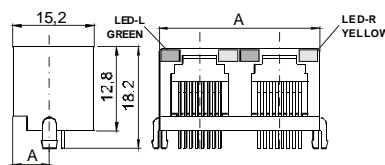

A	Number of Ports	CODE
15,75	1	2 DL188ZR
31,5	2	2 DL288ZR
63,3	4	2 DL488ZR
94,5	6	2 DL688ZR

For detailed PCB LAYOUT and ASSEMBLING DATA contact our sales department

## PCB MODULAR JACK - Shielded with LED indicators

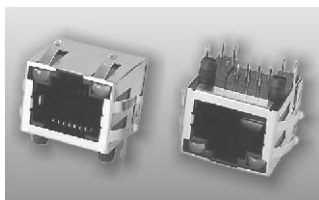

### ASSEMBLING DATA

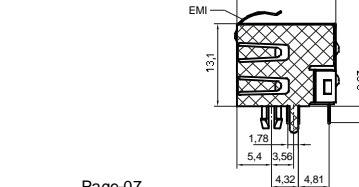

### PCB LAYOUT (Top view)

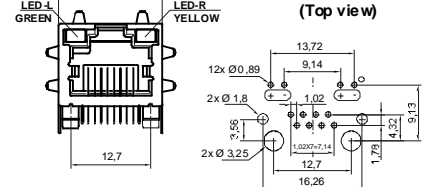

CODE
2 DFL188ZR

# PCB MODULAR JACKS



## SIDE ENTRY PCB MODULAR JACK

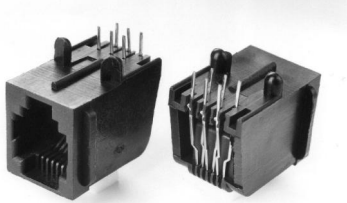

CODE	Possible contacts	Loaded contacts
2 DE 062	6	2
2 DE 064	6	4
2 DE 066	6	6
2 DE 088	8	8

### ASSEMBLING DATA

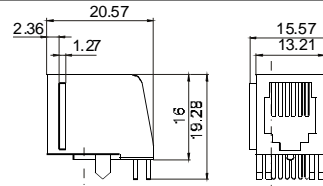

### PCB LAYOUT (Top view)

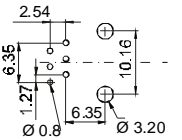

## TOP ENTRY PCB MODULAR JACK

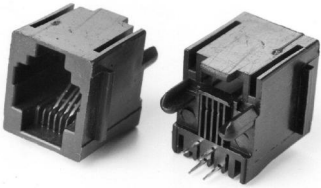

CODE	Possible contacts	Loaded contacts	Dimensions (mm)			
			A	B	C	D
2 DH 044	4	4	11,60	16,60	16,40	7,93
2 DH 062	6	2	13,30	15,90	15,50	10,10
2 DH 064	6	4	13,30	15,90	15,50	10,10
2 DH 066	6	6	13,30	15,90	15,50	10,10
2 DH 088	8	8	15,50	15,80	16,30	11,20

### ASSEMBLING DATA

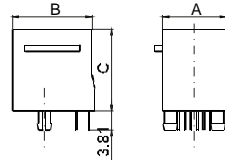

### PCB LAYOUT (Top view)

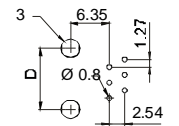

## PCB MODULAR JACK 4C

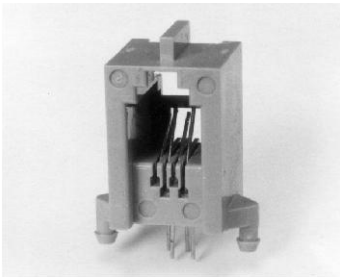

CODE	Possible contacts	Loaded contacts
2 DI 044	4	4

### ASSEMBLING DATA

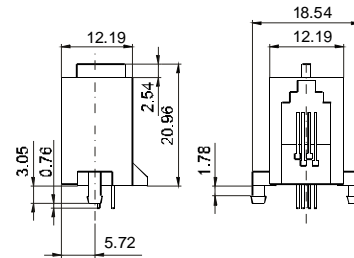

### PCB LAYOUT (Top view)

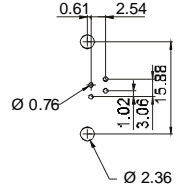

STANDARD COLOUR GREY \*Special order (other colours possible)

## PCB MODULAR JACK 6C

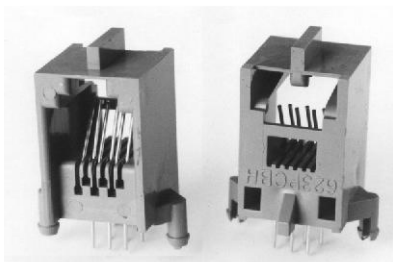

CODE	Possible contacts	Loaded contacts
2 DI 062	6	2
2 DI 064	6	4
2 DI 066	6	6

### ASSEMBLING DATA

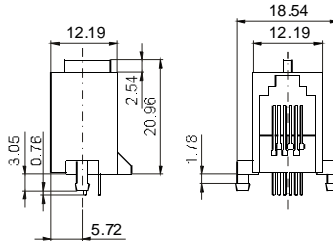

### PCB LAYOUT (Top view)

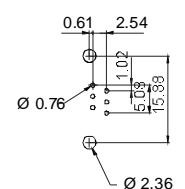

STANDARD COLOUR GREY \*Special order (other colours possible)

## PCB MODULAR JACK 8C

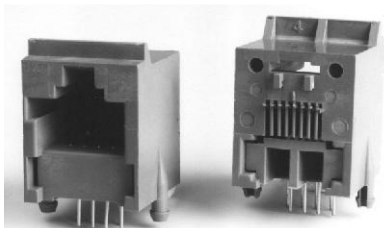

CODE	Possible contacts	Loaded contacts
2 DI 088	8	8

### ASSEMBLING DATA

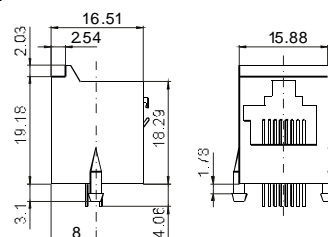

### PCB LAYOUT (Top view)

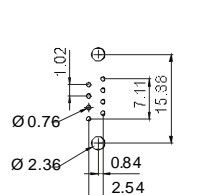

STANDARD COLOUR GREY \*Special order (other colours possible)

## SIDE ENTRY - LOW PROFILE

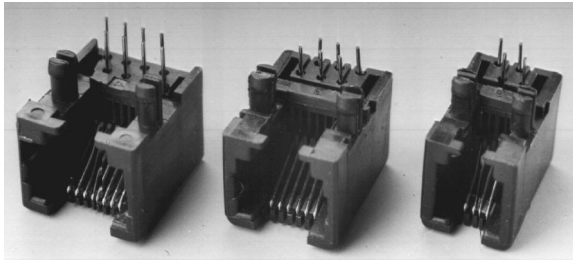

Dimensions (mm)

CODE	Possible contacts	Loaded contacts	A	B
2 DG 044	4	4	11,18	7,62
2 DG 062	6	2	13,20	10,16
2 DG 064	6	4	13,20	10,16
2 DG 066	6	6	13,20	10,16
2 DG 088	8	8	15,24	11,43
2 DG 100	10	10	15,24	11,43

ASSEMBLING DATA 18

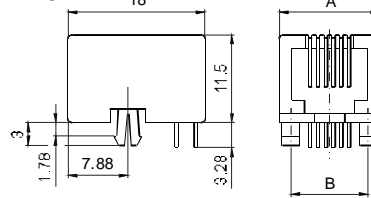

PCB LAYOUT (Top view)

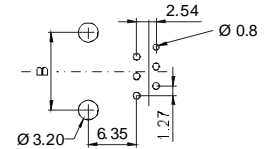

## PCB GANG MODULAR JACK

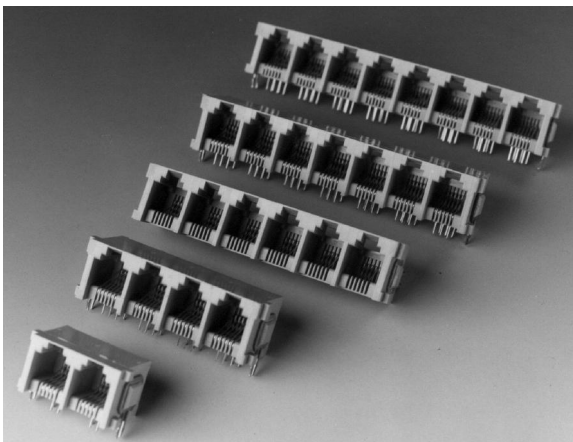

Dimensions (mm)

No. of Ports	A	B	C
2	28,20	25,20	11,00
3	39,20	36,20	22,00
4	50,20	47,20	33,00
5	61,20	58,20	44,00
6	72,20	69,20	55,00
7	83,20	80,20	66,00
8	94,20	91,20	77,00

HOW TO ORDER

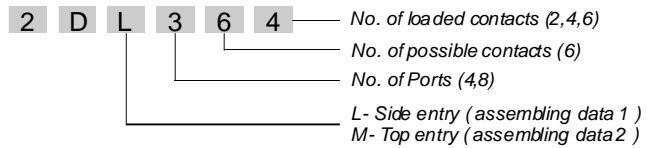

ASSEMBLING DATA 1 - (SIDE ENTRY)

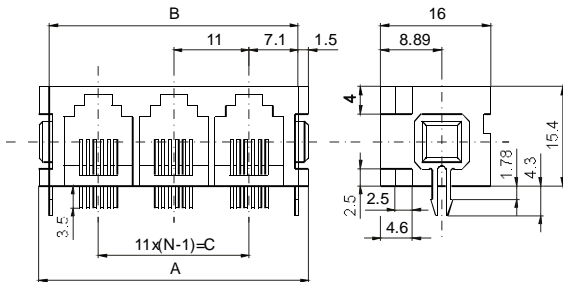

ASSEMBLING DATA 2 - (TOP ENTRY)

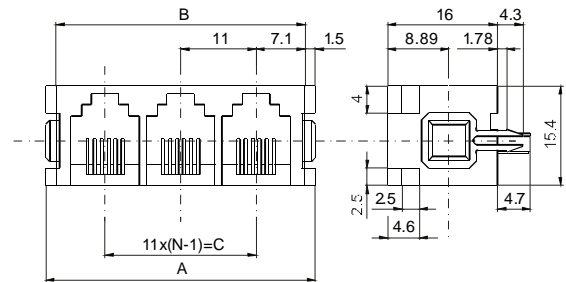

PCB LAYOUT (Top view)

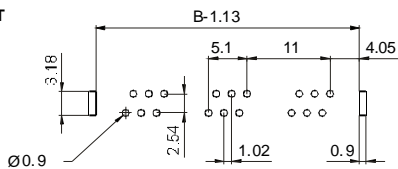

PCB LAYOUT (Top view)

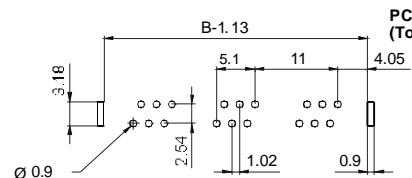

## BOTTOM ENTRY PCB MODULAR JACK

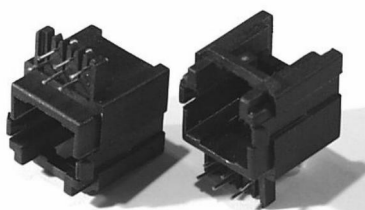

ASSEMBLING DATA

CODE	Possible contacts	Loaded contacts
2 DU 062	6	2
2 DU 064	6	4
2 DU 066	6	6

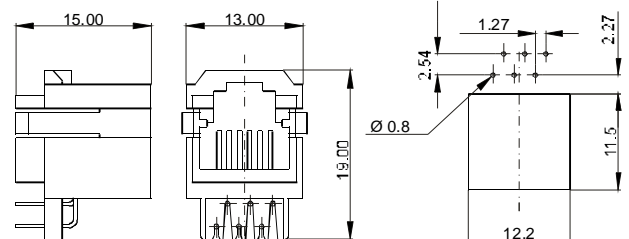

## UNIVERSAL MODULAR JACK

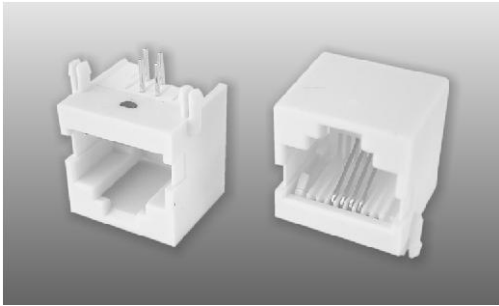

Can be plugged 6P or 8P modular plug

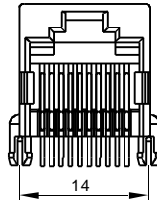
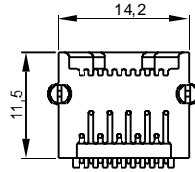

CODE	Possible contacts	Loaded contacts	Gold plated	Colour
2 DD0864B	6 or 8	4	6 $\mu$ Inch	White
2 DD1864B	6 or 8	4	15 $\mu$ Inch	White
2 DD3864B	6 or 8	4	30 $\mu$ Inch	White
2 DD0864C	6 or 8	4	6 $\mu$ Inch	Black
2 DD1864C	6 or 8	4	15 $\mu$ Inch	Black
2 DD3864C	6 or 8	4	30 $\mu$ Inch	Black

## MODULAR WIRING JACKS

### TECHNICAL SPECIFICATIONS

#### MATERIAL:

- HOUSING** : ABS Resin 94V-0
- CONTACT** : 0,45 mm (0,018 inch) Diameter, Phospor Bronze Alloy
- WIRE** : 26 AWG, 7 stands, UL-1061 E 1396 AWM 8C VW-1 300V
- INSULATION** : PE
- LENGTH OF WIRES** : 55 mm ( See page bottom)

#### ELECTRICAL CHARACTERISTICS:

- Insulation Resistance**: Min 10 M $\Omega$
- Contact Resistance**: Max 20 m $\Omega$
- Dielectric Withstanding Voltage**: 1000 Vrms 50 Hz
- Current Rating**: 1,5 A

## MODULAR WIRING JACK

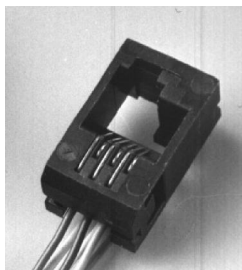
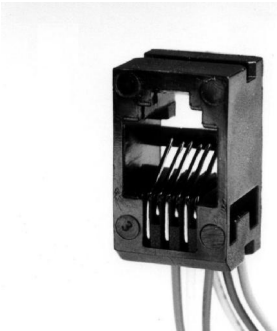

MODULAR DEC WIRING JACK

CODE	Possible contacts	Loaded contacts	Dimension: A	Dimension: B
2 DA 050	4	4	20	10
2 DA 062	6	2	20	12
2 DA 063	6	3	20	12
2 DA 061	6	4	20	12
2 DA 060	6	6	20	12
2 DB 966	6	6	20	12

#### ASSEMBLING DATA

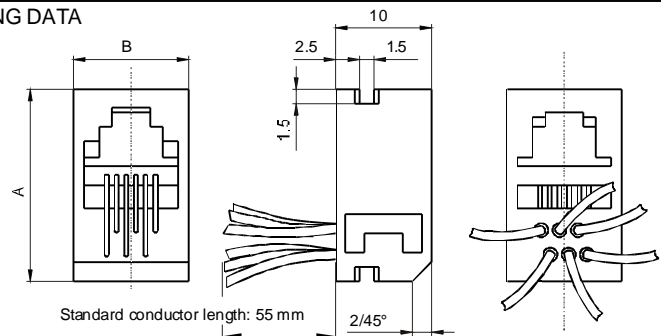

#### ASSEMBLING DATA 2DB 966

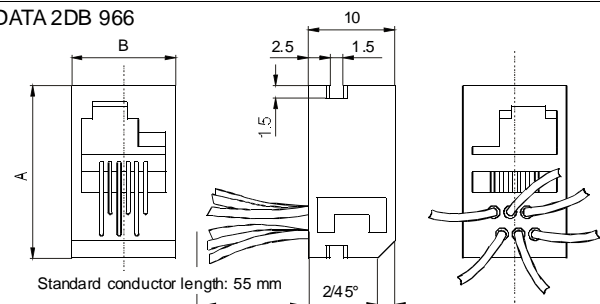

#### \* Special order:

- Other conductor lengths possible
- Inserts can be loaded with different number of conductors
- Conductors can be different colours
- End of conductor can be crimped with different contacts (see page 16, 17 - cables accessories)

## MODULAR WIRING JACK



CODE	Possible contacts	Loaded contacts
<b>2 DJ 088 L</b>	8	8
<b>2 DJ 100</b>	10	10

\* Special order: different lengths and colours of conductors, crimped end,...

### ASSEMBLING DATA

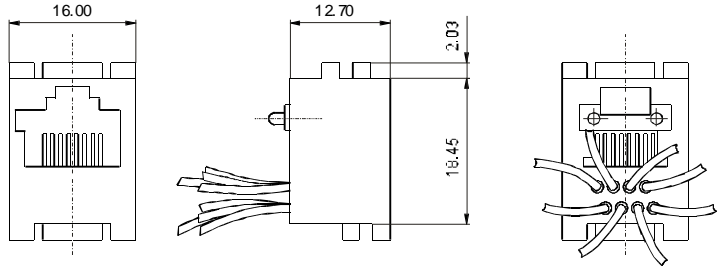

## MODULAR WIRING JACK 623K

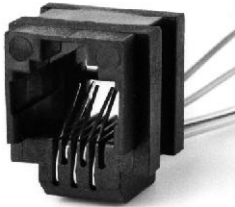

CODE	Possible contacts	Loaded contacts
<b>2 DK 062</b>	6	2
<b>2 DK 064</b>	6	4
<b>2 DK 066</b>	6	6

\* Special order: different lengths and colours of conductors, crimped end,...

### ASSEMBLING DATA

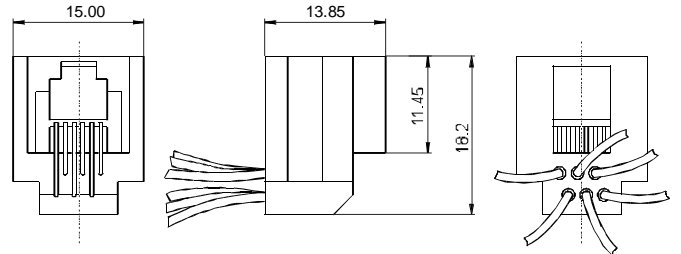

## MODULAR WIRING JACK 616E

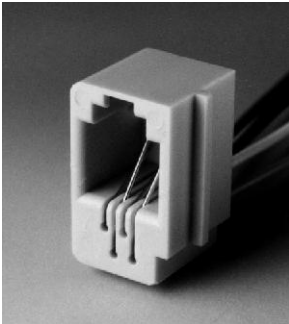

CODE	Possible contacts	Loaded contacts
<b>2 DK 616E</b>	4	4

\* Special order: different lengths and colours of conductors, crimped end,...

### ASSEMBLING DATA

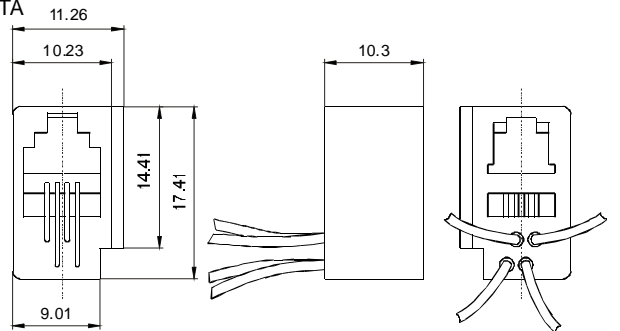

## MODULAR WIRING JACK 616W

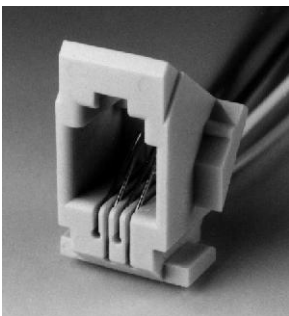

CODE	Possible contacts	Loaded contacts
<b>2 DK 616W</b>	4	4

\* Special order: different lengths and colours of conductors, crimped end,...

### ASSEMBLING DATA

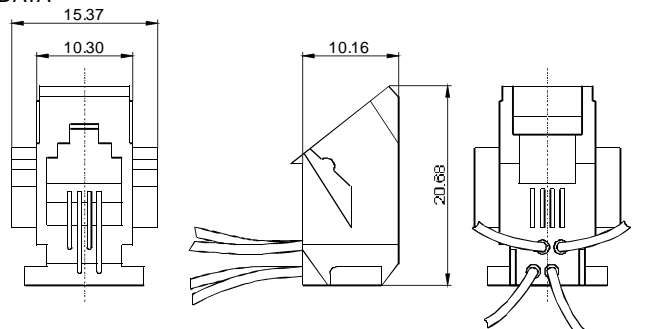

## INSERT 6P

CODE	Possible contacts	Loaded contacts
2 DV 162	6	2
2 DV 163	6	3
2 DV 164	6	4
2 DV 166	6	6

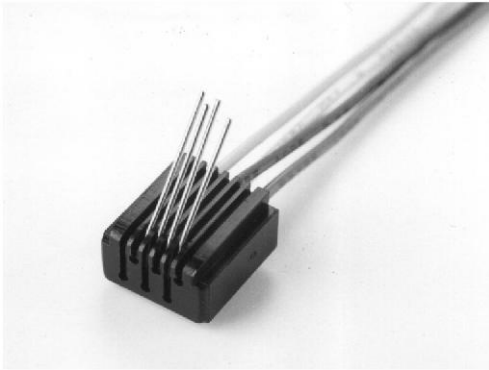

### ASSEMBLING DATA

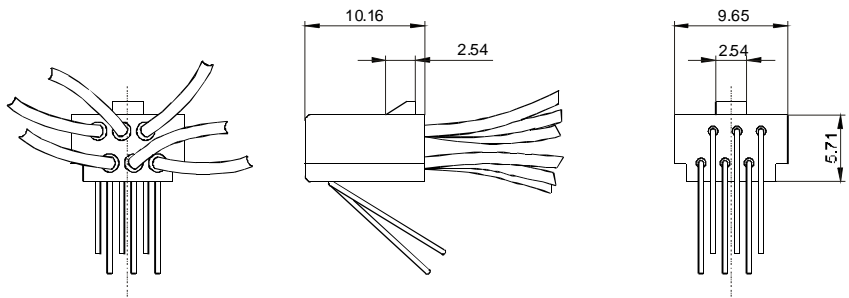

## INSERT 8P

CODE	Possible contacts	Loaded contacts
2 DV 188	8	8

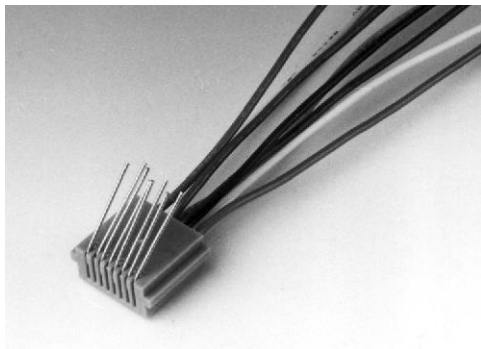

### ASSEMBLING DATA

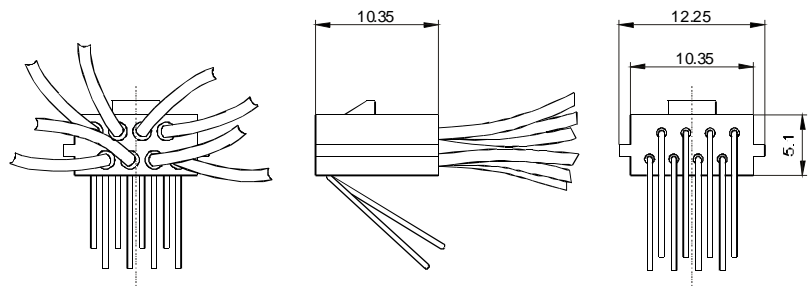

Standard conductor length is 55 mm

\* Special order:

- Other conductor lengths possible
- Inserts can be loaded with different number of conductors
- conductors can be different colours
- The free end of conductor can be crimped with different contacts (see page 16, 17)

## UNIVERSAL CRIMPING TOOL FOR MODULAR PLUGS

Orange	1 PA 111 O
Blue	1 PA 111 M

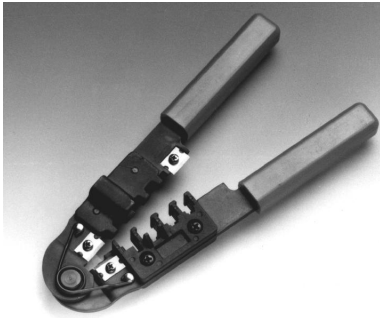

### CRIMPING TOOL FOR:

1. Modular plugs 4 C
2. Modular plugs 6 C
3. Modular plugs 8 C
4. DEC - modular plugs 6 C

## PROFESSIONAL CRIMPING TOOL FOR MODULAR PLUGS WITH EXCHANGEABLE INSERTS

1 PA 200

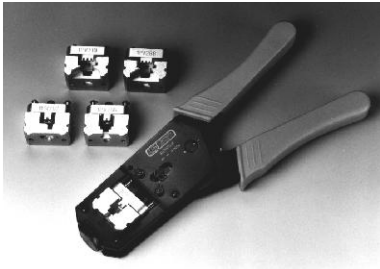

CODE	Description of insert
1 PA 200	Base crimping toll
1 PV 244	for 4C modular plugs
1 PV 266	for 6C modular plugs
1 PV 288	for 8C modular plugs
1 PV 210	for 10C modular plugs
1 PV 267	for 6C DEC modular plugs

## ALL IN ONE MODULAR CRIMPING TOOL

1 PA 025

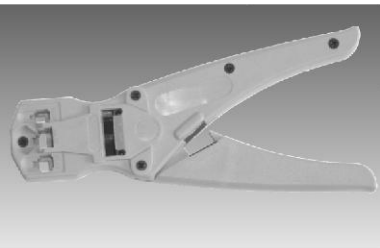

1. Modular plugs 4 C
2. Modular plugs 6 C
3. Modular plugs 8 C

## STANDARD CRIMPING TOOL

1 PA 003

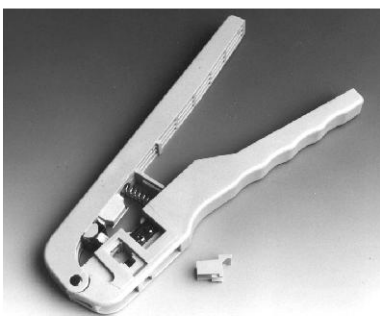

### FEATURES:

- \* light (90 g)
- \* easy to use
- \* low price
- \* use for modular plugs 4C and 6C

## STRIPPING TOOL FOR TELEPHONE CABLE UTP/STP Cat.5, COAXIAL AND FLAT CABLES

1 PA 010

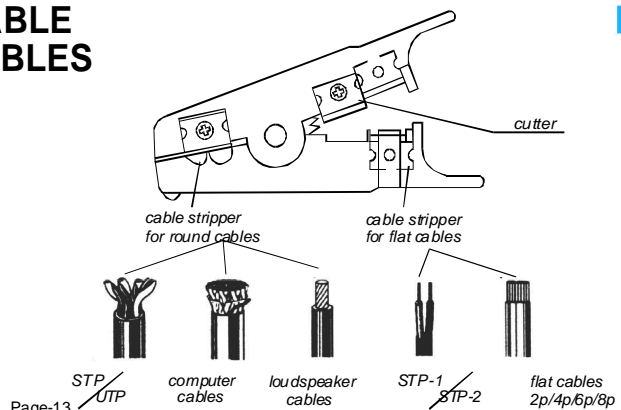
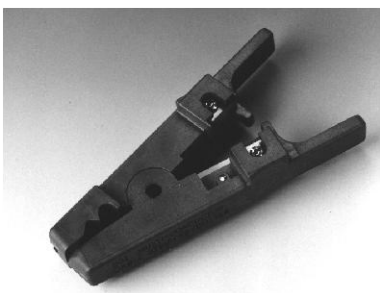

## PROFESSIONAL CRIMPING TOOL FOR TELEPHONE TERMINALS

1 PK 007

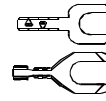
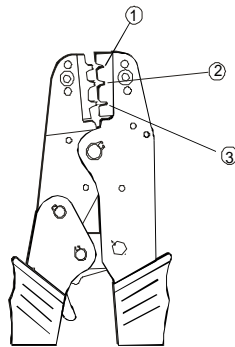
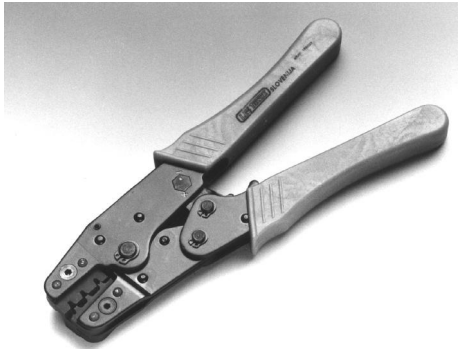

Spade tongue terminals

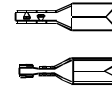

Quick disconnect terminals

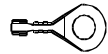

Ring tongue

**NOTES:**

1. For two way crimping of spade tongues, ring tongues and quick disconnectable terminals
2. For one way crimping of spade tongues, ring tongues and quick disconnectable terminals

## COAXIAL CABLE STRIPPER WITH ADJUSTABLE KNIVES

1 PB 057

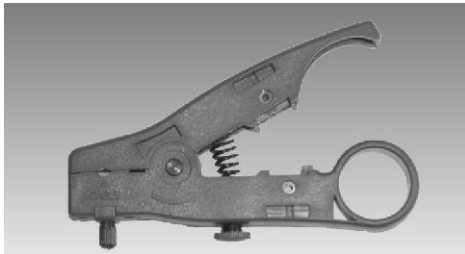

**CABLE STRIPPER:**

- Coaxial cable stripper for RG 174/58/59/62/6/3C/4C/5C

## LOW IMPACT INSERTION TOOL FOR LSA TERMINAL BLOCS

1 PK 110

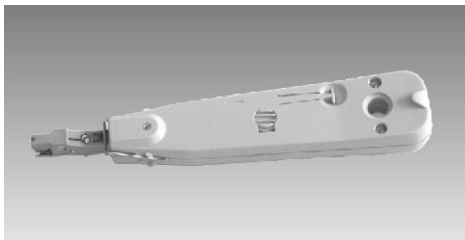

**LOW IMPACT INSERTION TOOL:**

- Insertion tool with sensor for modules

## IMPACT PUNCH-DOWN TOOLS FOR 110 TERMINAL BLOCS

1 PK 111

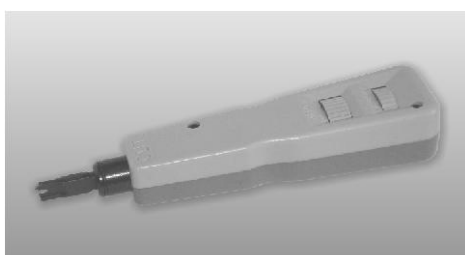

**NOTES:**

- Adjustable (HI-LO) spring-loaded impact mechanism.
- Storage bin on handle for spare blade.



## FLAT TELEPHONE LINE CORD

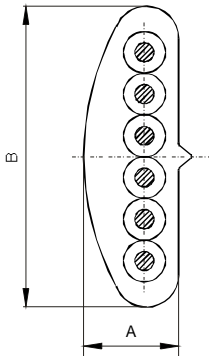

### CONDUCTOR:

- Type: 26 AWG - ( 0,14 mm<sup>2</sup> )
- Material: Stranded bare copper ( 7X 0,16 mm )

### JACKET:

- Material: PVC
- Colour: black, white, silver or customer request
- Temperature range: -20° C to +60 °C
- Max voltage rating: 300 V

### INSULATION OF CONDUCTOR:

- Material: Polypropylene
- Thickness: 0,25 mm
- Outside diameter: 100 mm

CODE: AWG 26			Dimension (mm)	
Black	White	No. of conductors	A	B
9 LA 004	9 LA 104	2X	2,5	5
9 LA 006	9 LA 106	4X	2,5	5
9 LA 007	9 LA 107	6X	2,5	7
9 LA 008	9 LA 108	8X	2,5	9
9 LA 010	9 LA 110	10X	2,5	11

CODE: AWG 28			Dimension (mm)	
Black	White	No. of conductors	A	B
9LA024N	9LA124N	2X	2,5	5
9LA026N	9LA126N	4X	2,5	5

## ROUND TELEPHONE LINE CORD

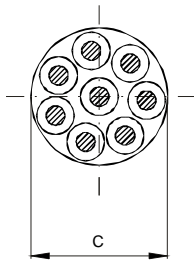

### CONDUCTOR:

- Type: 26 AWG - ( 0,14 mm<sup>2</sup> )
- Material: Stranded bare copper ( 7X 0,16 mm )

### JACKET:

- Material: PVC
- Colour: black, white, silver or customer request
- Temperature range: -20° C to +60 °C
- Max voltage rating: 300 V

### INSULATION OF CONDUCTOR:

- Material: Polypropylene
- Thickness: 0,25 mm
- Outside diameter: 100 mm

CODE		No. of conductors	Dimension C ( mm )
Black	White		
9 LO 002	9 LO 102	2	2,5 - 3,6
9 LO 003	9 LO 103	3	2,9 - 4,4
9 LO 004	9 LO 104	4	3,4 - 4,25
9 LO 006	9 LO 106	6	4,45 - 5,2
9 LO 008	9 LO 108	8	5,3 - 6,1

## FLAT & ROUND HANDSET CORD (FOR SPIRALIZATION)

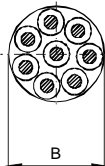
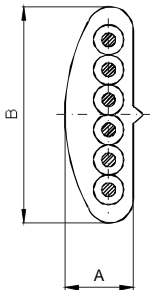

### CONDUCTOR:

- Type: 32 AWG - ( 0,032 mm<sup>2</sup> )
- Material: Stranded tinsel wire ( 4 / T 250 )

### INSULATION OF CONDUCTOR:

- Material: Polypropylene
- Thickness: 0,25 mm
- Outside diameter: 100 mm

### JACKET:

- Material: PVC
- Colour: black, white, red, violet, yellow, blue.
- Temperature range: -20 °C to +60 °C
- Max voltage rating: 300 V

### OPTION: Extension line cord for coiling

- Jacket material: PVC/PU
- Conductor: AWG 26

CODE				Dimensions (mm)		
Black	White	Red	Type of cable	No. of conductors	A	B
9 LB 004	9 LB 104	9 LB 404	flat	4	2,50	5,00
9 LB 006	9 LB 106	9 LB 406*	flat	6	2,50	7,00
9 LB 008	9 LB 108	9 LB 408*	flat	8	2,50	9,00
9 LP 004	9 LP 104	9 LP 454*	round	4	-	4,25
9 LP 006	9 LP 106	9 LP 406*	round	6	-	5,10
9 LP 008			round	8	-	6,00

CODE				Dimensions (mm)		
Violet ( Purple )	Yellow	Blue	Type of cable	No. of conductors	A	B
9 LB 604*	9 LB 704*	9 LB 914*	flat	4	2,50	5,00
9 LB 606*	9 LB 706*	9 LB 806*	flat	6	2,50	7,00
9 LP 604*	9 LP 704*	9 LP 854*	round	4	-	4,25
9 LP 606*	9 LP 706*	9 LP 806*	round	6	-	5,10

\* Special order

## SUPER SLIM FLAT CABLE (30 AWG)

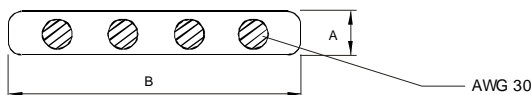

CODE		Dimension (mm)	
Transparent	No. of conductors	A	B
9 LS 300	4 x	0,48	4,1

## COAXIAL CABLE

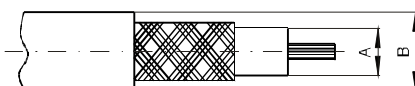

CODE			Dimensions (mm)	
CODE	Type	Impedance OHM	A	B
9 LK 001	RG-58	50	2,95	4,95
9 LK 003	RG-59	75	3,71	6,15

ASSEMBLING DATA

OPTION : Also other types possible

## FTP CAT5e CABLE

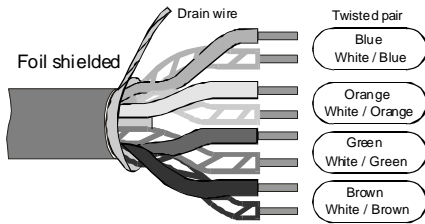

CODE	Type	AWG	Jacket Colour
9 LC 008	FTP Cat 5e Strand.	26	Grey
9 LC 018	FTP Cat 5e Solid	24	Grey

## UTP CAT5e CABLE

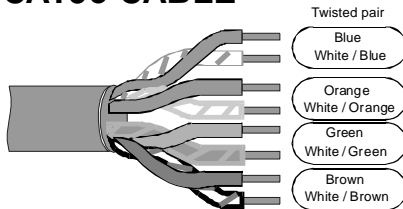

CODE	Type	AWG	Jacket Colour
9 LC 028	UTP Cat 5e Strand.	26	Grey
9 LC 038	UTP Cat 5e Solid	24	Grey
9 LC 128M	UTP Cat 5e Strand.	26	Blue
9 LC 128R	UTP Cat 5e Strand.	26	Red
9 LC 128RU	UTP Cat 5e Strand.	26	Yellow
9 LC 128Z	UTP Cat 5e Strand.	26	Green

## UTP CAT6 CABLE

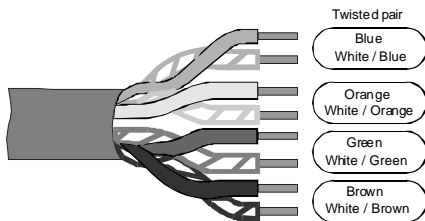

CODE	Type	AWG	Jacket Colour
9 LC 068	UTP Cat 6 Strand.	26	Grey
9 LC 069	UTP Cat 6 Solid	24	Grey

## TELEPHONE INSTALATION WIRE WITH PVC ISOLATION



		0,4	0,6	0,8
Resistance	$\Omega$ /km	92,65	63,95	35,97
Resistance of isolation (min)	M $\Omega$ /km	0,165	0,148	0,110
Testing voltage (2 sec. DC)	V	220		
core / core				

CODE	Type	Diameter	Jacket Colour
9 LI 042 M	Solid twisted	2 x 0,4	White / Blue
9 LI 062 M	Solid twisted	2 x 0,6	White / Blue
9 LI 082 M	Solid twisted	2 x 0,8	White / Blue

# CABLE ACCESSORIES

## SPADE TONGUE TERMINALS

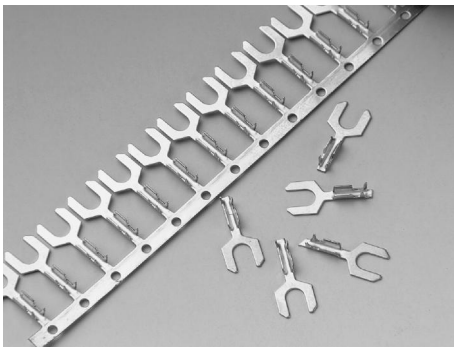

Use :	For crimping on cable : - AWG 32 = 0,034 mm <sup>2</sup> - AWG 30 = 0,057 mm <sup>2</sup> - AWG 28 = 0,088 mm <sup>2</sup> - AWG 26 = 0,14 mm <sup>2</sup> - AWG 24 = 0,22 mm <sup>2</sup>
Material :	- Brass - Tined brass - New silver

CODE	Area protection	Packing	Crimping type
5 AM 001	-	Chain form	One way
5 AM 101	-	Loose form	One way
5 AM 010	-	Chain form	Two way

### ASSEMBLING DATA

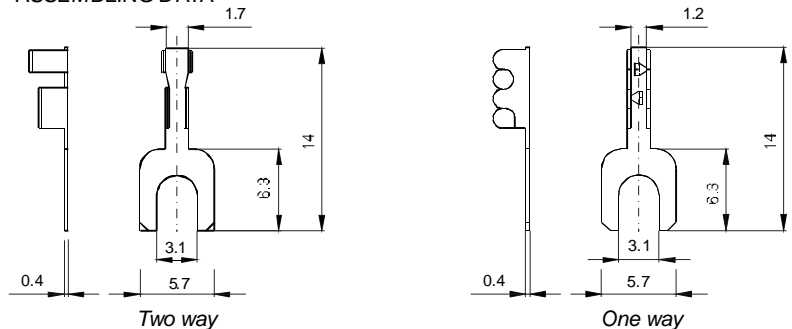

## QUICK DISCONNECTABLE TERMINALS



CODE	Area protection	Packing
5 EM 001	-	Chain form
5 EM 101	-	Loose form
5 DM 001	Tinned	Chain form
5 DM 101	Tinned	Loose form

### ASSEMBLING DATA

Use :	For crimping on cable :
	- AWG 32 = 0,034 mm <sup>2</sup> - AWG 30 = 0,057 mm <sup>2</sup> - AWG 28 = 0,088 mm <sup>2</sup> - AWG 26 = 0,14 mm <sup>2</sup> - AWG 24 = 0,22 mm <sup>2</sup>
Material :	- Brass
	- Tinned brass
	- New silver

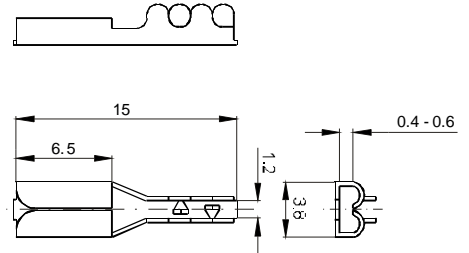

## “ O “ TERMINALS



CODE	Area protection	Packing	Crimping type
5 AM 000	-	Chain form	Two way
5 AM 100	-	Loose form	Two way

### ASSEMBLING DATA

Use :	For crimping on cable :
	- AWG 32 = 0,034 mm <sup>2</sup> - AWG 30 = 0,057 mm <sup>2</sup> - AWG 28 = 0,088 mm <sup>2</sup> - AWG 26 = 0,14 mm <sup>2</sup> - AWG 24 = 0,22 mm <sup>2</sup>
Material :	- Brass
	- Tinned brass
	- New silver

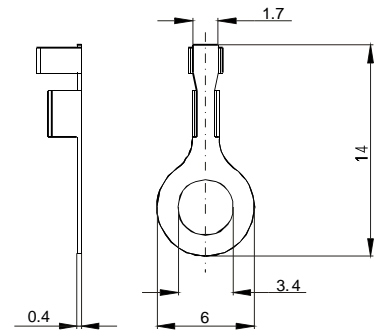

## PROTECT SLEEVES



CODE		Description	Cable type	Hole (mm)	Draw.
Black	White				
3 LP 011	3 LP 111	Long for TAE and TSS plug	Round	Ø 4	1
3 LP 012	3 LP 112	Long for TAE and TSS plug	Flat	-	2
3 LP 013	3 LP 113	Short	Round	Ø 4	4
3 LP 014	3 LP 114	Short	Round	Ø 5	4
3 LP 015	3 LP 115	Short	Flat	-	5
3 LP 016	3 LP 116	Long	Round	Ø 5	1
3 LP 021	3 LP 121	Long	Round	Ø 3	1
3 LP 022	3 LP 122	Long	Flat	-	3
3 LP 024	3 LP 124	Long	Round	Ø 4	1
3 LP 030	3 LP 130	For modular plugs 8P and 10P	Round	Ø 5,3	6
3 LP 430	Red	For modular plugs 8P and 10P	Round	Ø 5,3	6
3 LP 730	Yellow	For modular plugs 8P and 10P	Round	Ø 5,3	6
3 LP 830	Grey	For modular plugs 8P and 10P	Round	Ø 5,3	6
3 LP 930	Blue	For modular plugs 8P and 10P	Round	Ø 5,3	6

### ASSEMBLING DATA

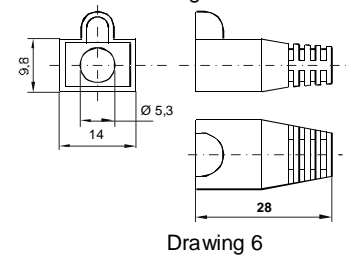
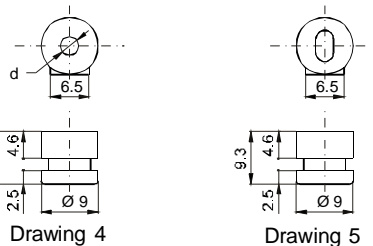
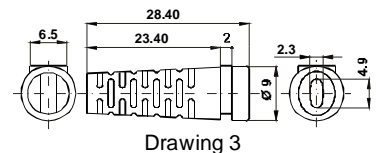
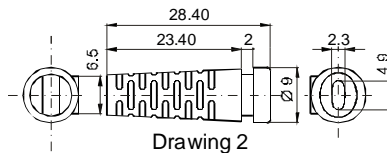
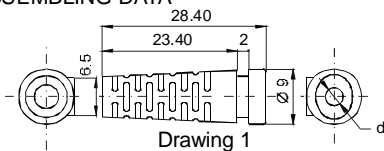

Material	PVC
Max. temperature:	80 °C
Use:	For all types of round and flat cables

## PROTECT SLEEVES - HAMMER TYPE



CODE	Type of cable	d (mm)	Assembling data
3 LP 046	Flat	5 x 2,75	1
3 LP 040	2C round	3,2	2
3 LP 041	4C round	4,6	2
3 LP 042	6C round	5,3	2
3 LP 043	2C round	3,4	2
3 LP 034	Round	6	3

ASSEMBLING DATA: 1

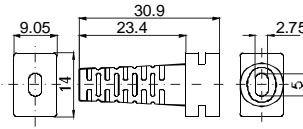

ASSEMBLING DATA: 2

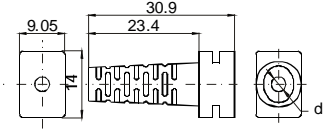

ASSEMBLING DATA: 3

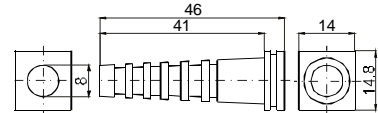

Material	PVC
Max. temperature:	80 °C
Use:	For all types of round and flat cables

## PROTECT SLEEVES FOR 8P AND 10P MODULAR PLUGS



CODE					
Yellow	Blue	Green	Red	Black	Grey
3 LP 731	3 LP 931	3 LP 531	3 LP 431	3 LP 047	3 LP 831

ASSEMBLING DATA

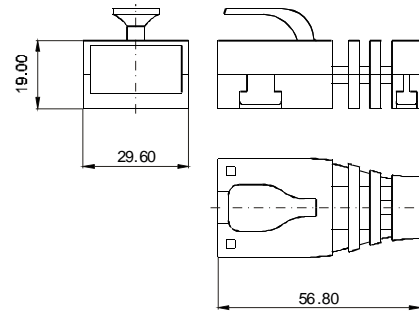

## CABLE CLIPS

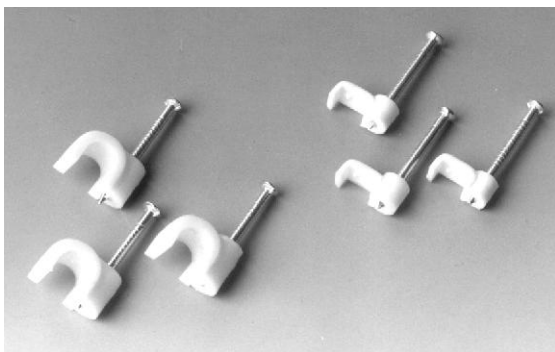

CODE	Type of cable	Hole (mm)	Assembling data
2 RO 006	Round	5	1
2 RA 006	Flat	4,8 x 2,1	2

ASSEMBLING DATA 1

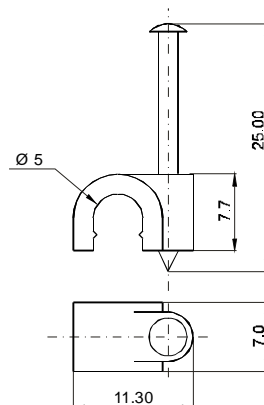

ASSEMBLING DATA 2

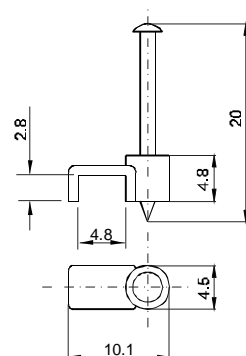

## TERMINAL BLOCKS FOR PCB (Solder type)

### TECHNICAL DATA

#### FEATURES:

- \* Standard sizes are 2 and 3 way blocks, but more contacts can be combined, by simply plugging them together.
- \* Wire guard protects from direct screw contact.

#### MATERIAL:

1. **CONTACT** : Brass (CuZn) tin plated
2. **TERMINAL SCREW** : Galvanized and chromium - plated steel
3. **WIRE GUARD** : Cu Sn6
4. **SURFACE OF SOLDER TAIL** : Tin plated
5. **INSULATOR BODY** : Polyamide 6.6

#### MECHANICAL CHARACTERISTICS:

- \* **Operating temp.:** - 30 °C to 120 °C
- \* **Soldering temp.:** +260 °C, 10 Sec.

#### ELECTRICAL CHARACTERISTICS:

- \* **Current rating:** 10 A/way max

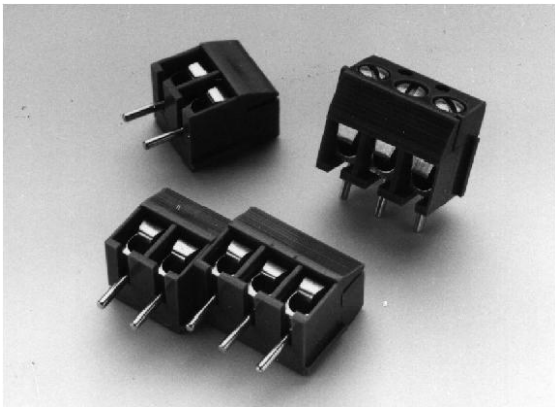

CODE	Spacing (mm)	No. of Poles
2 RS 015	3,5	2
2 RS 013	3,5	3
2 RS 011	3,5	6

#### ASSEMBLING DATA

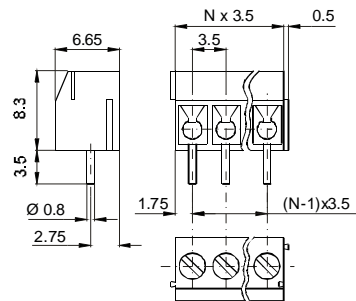

## LSA TERMINAL BLOCKS FOR PCB

CODE	Type of cable	Spacing (mm)	Assemb. data
2 RS 025	4C for PCB	3,81	1
2 RS 026	8C for PCB	3,81	2

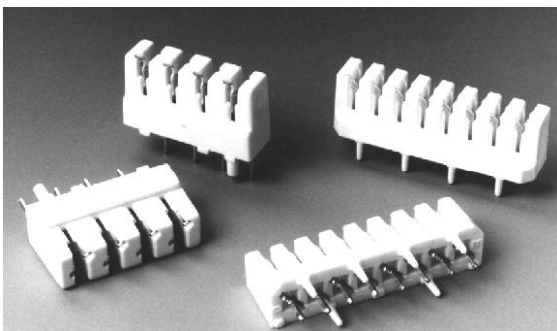

#### ASSEMBLING DATA 1

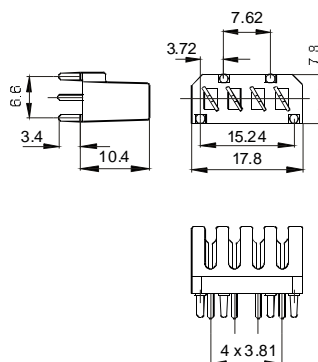

#### ASSEMBLING DATA 2

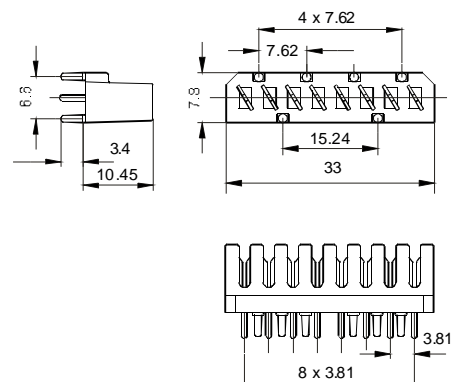

One side of the cord	Other side of the cord							
	Modular plug	Protect sleeve+ spade tongue terminals	Protect sleeve+ quick discond. terminals	Spade tongue terminals	Quick discond. terminals	Straight cut	Stripped jacket	Modular jack
Modular plug	A	B	C	D	E	F	G	V
Protect sleeve+ spade tongue terminals		H	I	J	K	L	M	Y
Protect sleeve+ quick discond. terminals			N	O	P	Q	R	Z
Spade tongue terminals				S	T	U	W	X
Quick discond. terminals					X	X	X	X

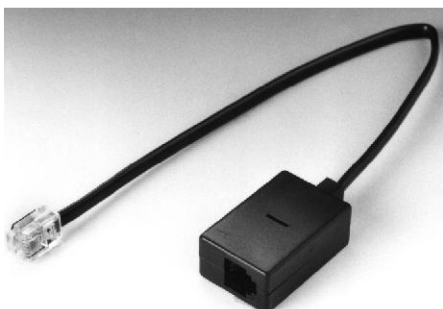
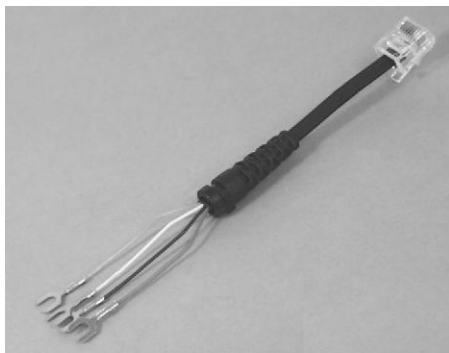
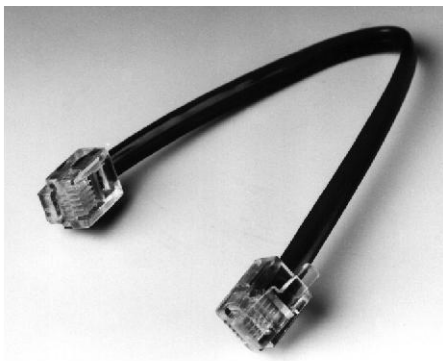

## 1BX...SPECIAL EXTENSION CORDS - EXACT DESCRIPTION NEEDED

### CODE SYSTEM :

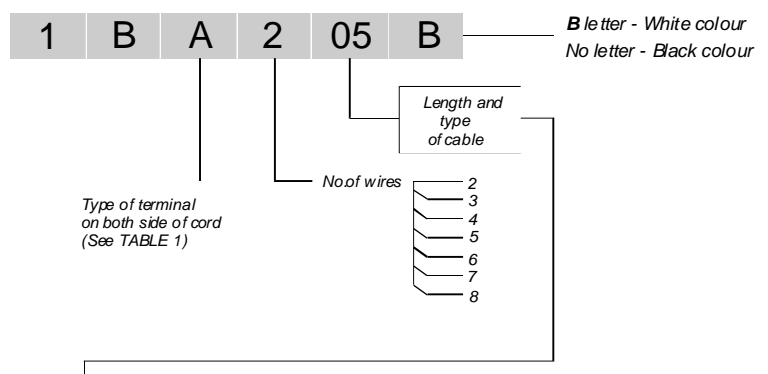

**TABLE 2: 5th and 6th place in the code**

Type of cable	STANDARD LENGTHS OF CABLE			
	0,2 m	5 m	10 m	15 m
Flat cable	72	05	10	15
Round cable	92	55	60	65

**EXAMPLE:** You need an extension cord which has a protect sleeve with quick disconnectable terminals on one side and straight cut on the other. Cable must be white, round with 6 wires and 0,2 m long.

1. Choose letter **Q** from the first table (**1BQ...**).
2. Choose number **6** for number of wires (**1BQ6....**).
3. Choose number **92** for length and type of cable from **TABLE 2.** (**1BQ692..**).
4. Choose letter **B** for white colour of cable.
5. The correct code for your extension cord is **1BQ 692 B.**

## HANDSET CORDS

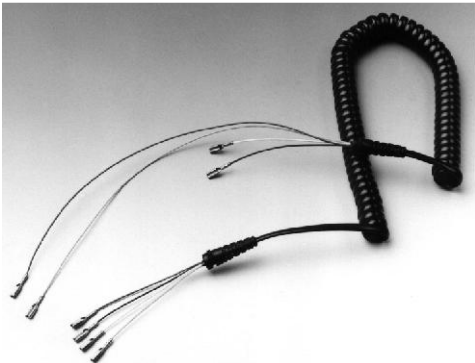
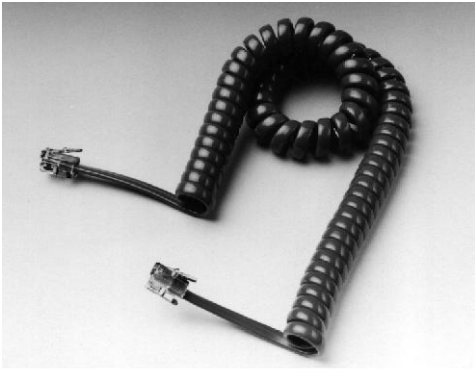

CODE		Length (m)	Both sides of the cord		
Black	White		Modular plug	Quick disconnect terminals	No. of wires
1LA 001	1LA 002	2,5	2/4x4	-	4
1LA 010	1LA 110	2,9	-	Yes	4
1LA 501	1LA 502	5	2/4x4	-	4
1LA 510	1LA 512	5	-	Yes	4

**NOTE :**  
also other types possible ( round cable, other colours, different lengths,....)

**MATERIAL :**  
standard cable is flat with 32 AWG (0,032 mm ) conductor with stranded tinsel wire ( see page "cables - flat & round handset cord" ).

## TANGLE - FREE ADAPTER (SHORT)

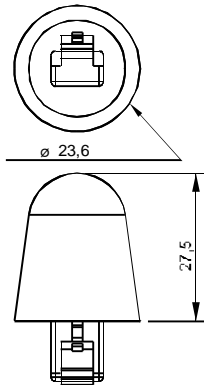

Colour	CODE
Black	1 AA 040
White	1 AA 040B
Transparent	1 AA 040T

### FEATURES:

- \* extends telephone cord life time
- \* impact resistant polycarbonate construction
- \* for home and office use
- \* gold plated contacts for optimum performance
- \* available colors: white, black and transparent

### SPECIAL ORDER

**TANGLE FREE ADAPTER** can be custom printed with your company logo, which makes it unique promotional item.

## TANGLE - FREE ADAPTER

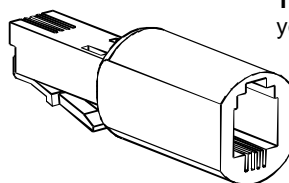

### SPECIAL ORDER

Colour	CODE
White	1 AA 040IB
Black	1 AA 040IC
Transparent	1 AA 040IT

**TANGLE FREE ADAPTER** can be custom printed with your company logo, which makes it unique promotional item.

# QUICK MOUNTING CHANNELS



## QUICK MOUNTING CHANNELS

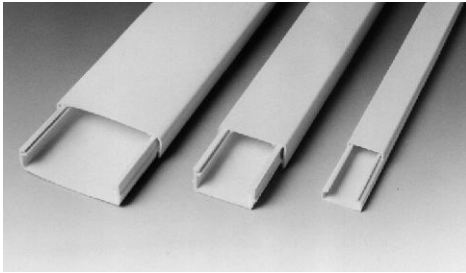

Standard color: White  
Special order: other colours possible

CODE	A x B (mm)
3 RP 131	15x17
3 RP 132	30x17
3 RP 133	40x25
3 RP 134	80x60
3 RP 135	40x40

### ASSEMBLING DATA

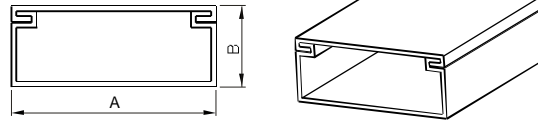

## QUICK MOUNTING CHANNELS WITH DOSES

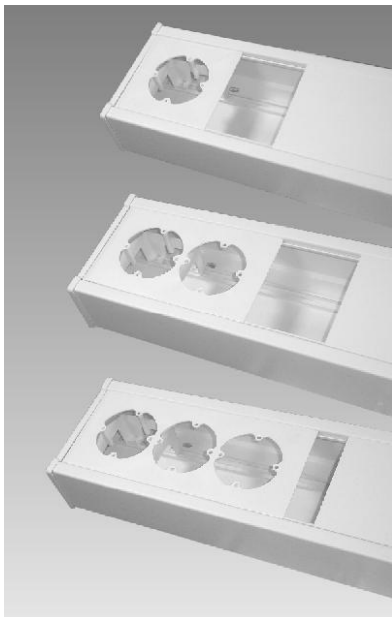

CODE	Description
3 RP 201	Channel "PK" 110x70
3 RP 205	Channel "PK" 140x70
3 RP 203	Dose for channel 3RP201
3 RP 204	End (cover) for 3RP 201
3 RP 206	End (cover) for 3RP 205
3 RP 230	Dose for channel 3RP205
3 RP 231	Montage frame - Single
3 RP 232	Montage frame - Double
3 RP 233	Montage frame - Triple

### ASSEMBLING DATA

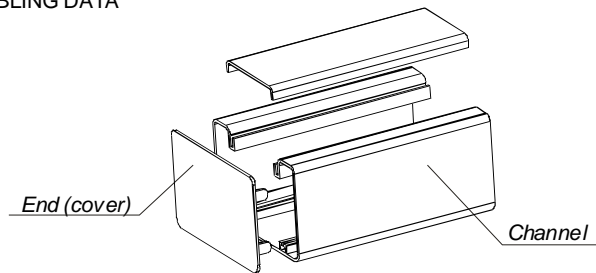

\* Special order: I, T, L adapters for dividing channel line; edge adapter etc.

## DIFFERENT COVERS FOR QUICK MOUNTING CHANNEL DOSES

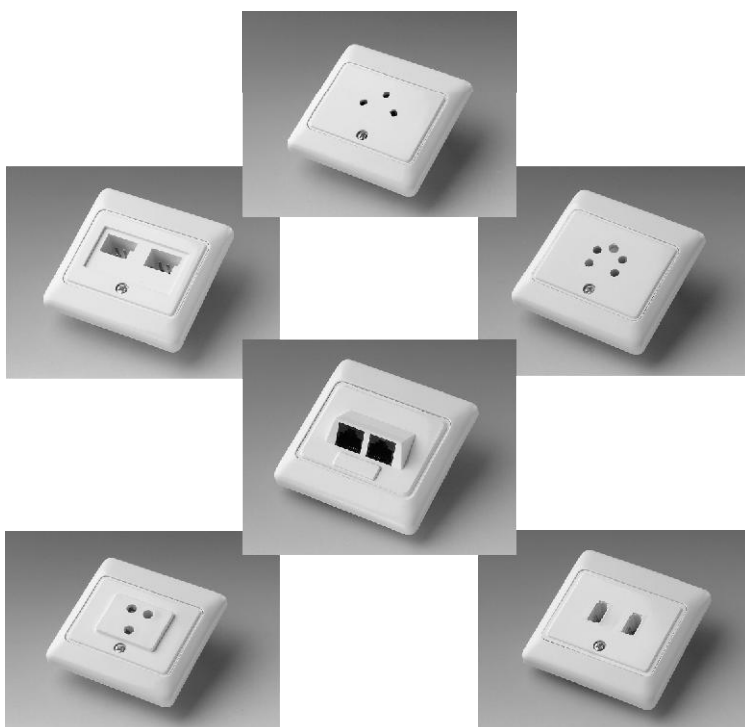

CODE	Country
1 DIAK 100	Italy
1 DJAK 200	Switzerland
1 DLAK 100	Belgium
1 DHAK 100	The Netherlands
1 DPAK 100	Russia, Poland, Bulgaria, Romania
1 DSAK 300	Austria
1 DAAK 100	Slovenia, Croatia, BiH, Serbia, Macedonia
1 DGAK 100	Czech Republic, Slovakia
1 DMAK 100	Hungary
1 DUAK 200	Great Britain
1 DTAK 100	Turkey
1 DNAK 300	Germany
1 DRAK 903	CAT 5
1 DRAK 913	ISDN



## ISDN EURO MODULAR JACK with integrated 2x100Ω resistors

CODE		MODULAR JACK
Flash mounting	Surface mounting	8/4
1 DRA 501	1 DRA 511	1X
1 DRA 502	1 DRA 512	2X



WIRING DIAGRAM  
1DRA501 and 1DRA511

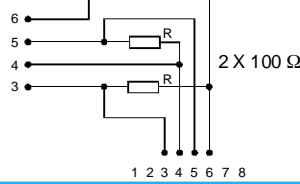

WIRING DIAGRAM  
1DRA502 and 1DRA512

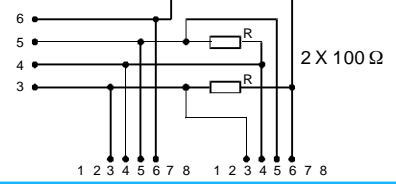

## UNIVERSAL EURO JACK



ISDN		
Flash mounting	Surface mounting	Wiring diagram
1DRAU502	1DRAU512	1

WIRING DIAGRAM 1

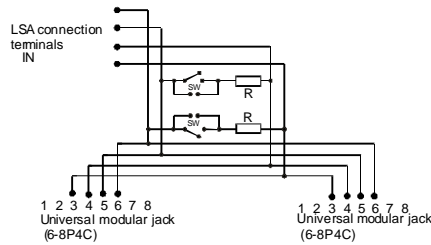

Analog or ISDN		
Flash mounting	Surface mounting	Wiring diagram
1DRAU542	1DRAU552	2

WIRING DIAGRAM 2

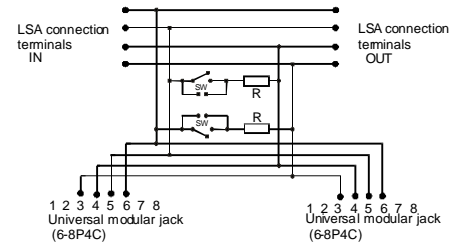

## ISDN/ RJ45 EURO JACK



### Surface mounting

Type:	Double	Single left	Single right
Code:	1DRA642	1DRA641L	1DRA641D

### Flash mounting

Type:	Double	Single left	Single right
Code:	1DRA652	1DRA651L	1DRA651D

## S<sub>0</sub> BUS-ISDN TERMINAL Connection adapter 1/4 or 1/8 with integrated 2x100 Ω resistor

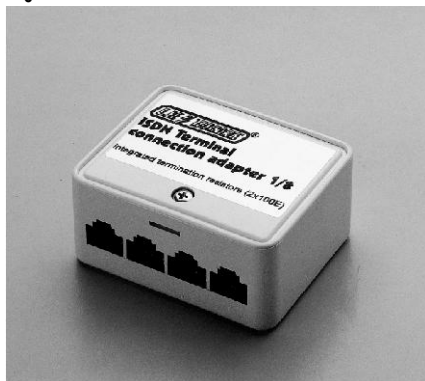

ASSEMBLING DATA

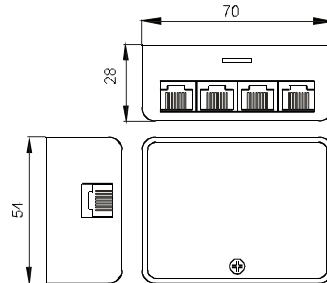

CODE	No. of inputs / outputs
1 DP 588P	1/4
1 DP 988P	1/8

WIRING DIAGRAM

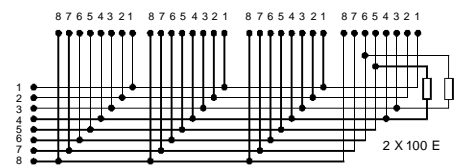

## ISDN TERMINATION

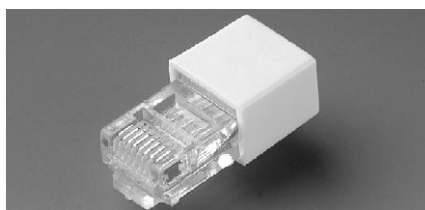

### FEATURES:

- 100 Ohm end with modular plug

Variant	CODE
Compact	2 CI 084
Magic box (1x RJ45)	1BBG0471ABR
Magic box (2x RJ45)	1BBI0491ABR

\* Variant: Magic box (see page 5)

## ADSL / POTS + ISDN (COMBO) SPLITTER

CODE

1 DP 400



### FEATURES:

- Small size
- Handles loop current up to 100 mA
- Includes surge arrester
- DC blocking capacitor for modem output
- Consist of all passive elements
- Operating temperature -40C° ... +85C°
- Complies to ITU-T G992.1, G922.3, G992.5 Annex B and ETSI TS 101 952-1-4 V1.1.1
- VDSL compatible
- POTS termination: 600 Ω and Z<sub>R</sub>
- ISDN termination: 135 Ω (2B1Q) and 150 Ω (4B3T)

## ADSL/POTS MICROFILTER

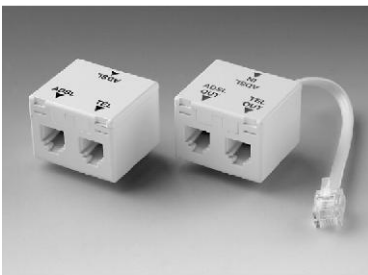

### FEATURES:

- Small size
- Low cost
- Handles loop current up to 100 mA
- Consist of all passive elements
- Available in different housing
- Includes RJ-45 jack for modem connection (option)
- Includes surge arrester (option)
- POTS termination: 600 Ω and Z<sub>R</sub>
- Operating temperature -40C° ... +85C°

Type	CODE	Cable
Analog	1 ZDF00VXBXA	No
Analog	1BBF0471ABXA	Yes

## ADSL/POTS MICROFILTER



### FEATURES:

- Small size
- Low cost
- Handles loop current up to 100 mA
- Consist of all passive elements
- POTS termination: 600 Ω and Z<sub>R</sub>
- Operating temperature -40C° ... +85C°

Cable	CODE
Yes	1BVA271SA

## MDF SPLITTERS

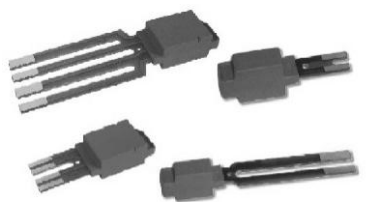

ADSL "ISDN or POTS" (COMBO) Splitter

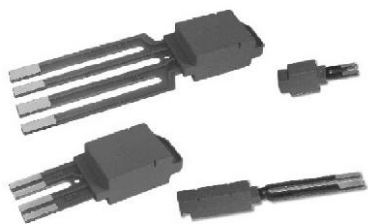

ADSL POTS 4 Port Splitter; LP + HP Filter

### COMBO VERSION (POTS & ISDN)

- Small size
- Handles loop current up to 100 mA
- Includes surge arrester (option)
- DC blocking capacitor for modem output (only for 4-port)
- Consist of all passive elements
- Operating temperature -40C° ... +85C°
- Complies to ITU-T G992.1, G922.3, G992.5 Annex B and ETSI TS 101 952-1-4 V1.1.1
- VDSL compatible
- POTS termination: 600 Ω and Z<sub>R</sub>
- ISDN termination: 135 Ω (2B1Q) and 150 Ω (4B3T)
- Available for different MDF blocks

### POTS VERSION

- Small size
- Handles loop current up to 100 mA
- Includes surge arrester (option)
- DC blocking capacitor for modem output (only for 4-port splitter)
- Consist of all passive elements
- Operating temperature -40C° ... +85C°
- Complies to ITU-T G992.1, G922.3, G992.5 Annex A and ETSI TS 101 952-1-1 V1.1.1
- POTS termination: 600 Ω and Z<sub>R</sub>
- Available for different MDF blocks

Type	CODE
Krone 4-Port (LP+HP filter)	1RX167A
Krone 2-Port (LP filter)	1RX167ALP
Siemens 4-Port (LP+HP filter)	1RX168A
Siemens 2-Port (LP filter)	1RX168ALP
Corning 4-Port (LP+HP filter)	1RX169A

With surge protection	
Krone 4-Port (LP+HP filter)	1RX167AZ
Krone 2-Port (LP filter)	1RX167ALPZ
Siemens 4-Port (LP+HP filter)	1RX168AZ
Siemens 2-Port (LP filter)	1RX168ALPZ
Corning 4-Port (LP+HP filter)	1RX169AZ

Type	CODE
Krone 4-Port (LP+HP filter)	1RX067A
Krone 2-Port (LP filter)	1RX067ALP
Siemens 4-Port (LP+HP filter)	1RX068A
Siemens 2-Port (LP filter)	1RX068ALP

With surge protection	
Krone 4-Port (LP+HP filter)	1RX067AZ
Krone 2-Port (LP filter)	1RX067ALPZ
Siemens 4-Port (LP+HP filter)	1RX068AZ
Siemens 2-Port (LP filter)	1RX068ALPZ

## NATIONAL TELEPHONE ADAPTERS WITH BUILT IN ADSL/POTS FILTERS



France

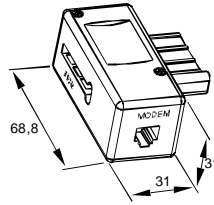

Country	CODE
France	1AF101A



Italy

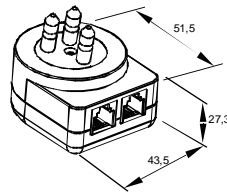

Country	CODE
Italy	1AI 134 A

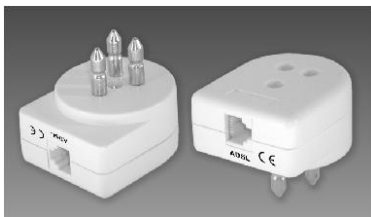

Italy - type B

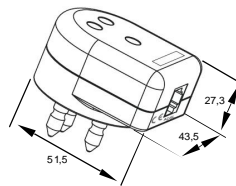

Country	CODE
Italy - type B	1AIN 001 A



Switzerland

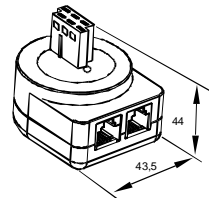

Country	CODE
Switzerland	1AK 138 A

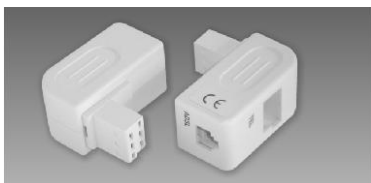

Switzerland - type B

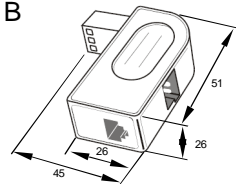

Country	CODE
Switzerland - type B	1AJ 104 A



Norway / Finland

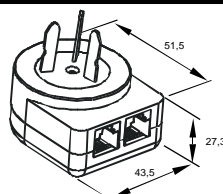

Country	CODE
Finland / Norway	1AFL 133 A

## NATIONAL TELEPHONE ADAPTERS WITH BUILT IN ADSL/POTS FILTERS



Belgium

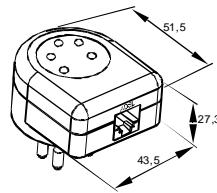

Country	CODE
Belgium	1ABL 101 A



Sweden

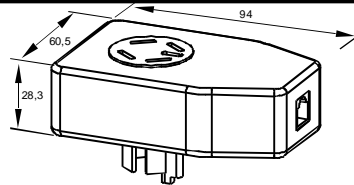

Country	CODE
Sweden	1ASW 101 A

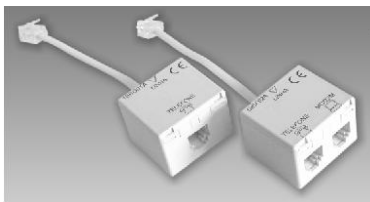

Brasil

- ANATEL homologation
- Small size
- Handles loop current up to 100 mA
- Consist of all passive elements
- POTS termination: 600 Ω
- Operating temperature -40C° ... +85C°

Type	CODE
Brasil - Telephone	1BBD01A
Brasil - Telephone & Modem	1BBF02A

## CATEGORY - 5

### CATEGORY 5e - EURO MODULAR JACK



Modul	Type	Double 8/8	Single 8/8 Left	Shielded
	Flash mount.	1 DRA 903	1 DRA 901L	No
Surface mount.	1 DRA 913	1 DRA 911L	No	
Flash mount.	1 DRA 702S	1 DRA701 SL	Yes*	
Surface mount.	1 DRA 712S	1 DRA 711SL	Yes*	

\*shielded versions are designed for FTP, STP, SFTP cable.

WIRING DIAGRAM

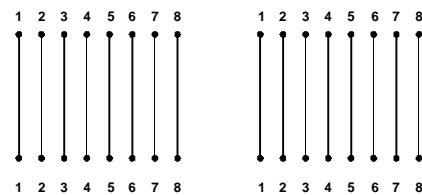

### UTP / STP PATCH CABLES

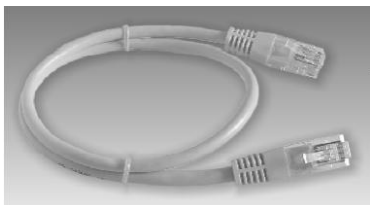

Type	CODE				
	0,5 m	1 m	3 m	5 m	10 m
UTP (CAT 5e)	1 BXU875M2	1 BXU801M2	1 BXU803M2	1 BXU805M2	1 BXU810M2
FTP (CAT 5e)	1BXF875ME	1BXF801ME	1BXF803ME	1BXF805ME	1BXF810ME
STP (shielded)	1BXS875M	1BXS801M	1BXS803M	1BXS805M	1BXS810M
SFTP (shielded)	1BXSf875M	1BXSf801M	1BXSf803M	1BXSf805M	1BXSf810M
UTP (CAT 6)	1 BXU6875M2	1 BXU6801M2	1 BXU6803M2	1 BXU6805M2	1 BXU6810M2
FTP (CAT 6)	1BXF6875M2	1BXF6801M2	1BXF6803M2	1BXF6805M2	1BXF6810M2

### COLORED UTP (Cat5e) PATCH CABLES

Colour	CODE				
	0,5 m	1 m	2 m	3 m	5 m
BLUE	1 BXU875M2M	1 BXU801M2M	1 BXU802M2M	1 BXU803M2M	1 BXU805M2M
RED	1BXU875MER	1BXU801MER	1BXU802MER	1BXU803MER	1BXU805MER
YELLOW	1BXU875MRU	1BXU801MRU	1BXU802MRU	1BXU803MRU	1BXU805MRU
GREEN	1BXU875MZ	1BXU801MZ	1BXU802MZ	1BXU803MZ	1BXU805MZ

\* Special order other colours of protect sleeves possible

## POWER LINE AND TELEPHONE LINE SURGE PROTECTION

1 EA 029 P



**SPECIFICATIONS:**

- POWER LINE:**
- L-N, N-GND, L-GND protection
  - Max. surge current: 4,5 KA
  - Max. clamping voltage: 710 V
- TELEPHONE LINE:**
- a-b, a-GND, b-GND protection
  - Max. surge current: 10 KA to GND  
2,5 KA a to b

Packed in Blister package

## POWER LINE AND ISDN LINE SURGE PROTECTION

$U_0$  BUS 1 EA 024 S  
 $S_0$  BUS 1 EA 024 N



**SPECIFICATIONS:**

- POWER LINE:**
- L-N, N-GND, L-GND protection
  - Max. surge current: 4,5 KA
  - Max. clamping voltage: 710 V
- ISDN LINE:**
- Rx, Tx, Rx -GND, Tx - GND
  - Dual stage protection

## POWER LINE SURGE PROTECTION

1 EA 119



**SPECIFICATIONS:**

- L-N, N-GND, L-GND protection
- Max. surge current : 4,5 KA
- Max. clamping voltage: 710 V

## POWER LINE AND ANTENNA SURGE PROTECTION

1 EA 023



**SPECIFICATIONS:**

- POWER LINE:**
- L-N, N-GND, L-GND protection
  - Max. surge current : 4,5 KA
  - Max. clamping voltage: 710 V
- ANTENNA:**
- Signal to shield protection
  - Max. surge current: 2,5 KA

## TELEPHONE LINE SURGE PROTECTION

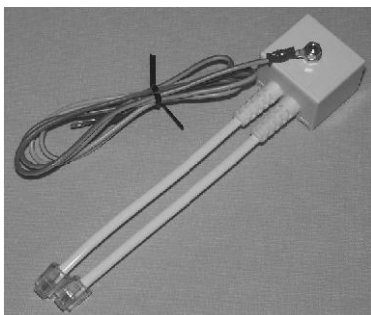

Protecting POTS line	1BCD02013A1B
Protecting 2 POTS lines	1BCF02013A2B
Protecting ISDN $S_0$ line	1BCG02013ADB1
Protecting ADSL line (RJ11)	1BCD02013ADB
Protecting ADSL line (RJ45)	1BCG02013ADB

**APPLICATIONS:**

- Analog (a b) outputs of ISDN modems
- Analog (a b) outputs of ISDN NT+2 a b
- Inputs of analog modems
- Telephones, fax

**SPECIFICATIONS:**

- Two independent tel. line protections
- a-b, a-GND, b-GND protection
- Max. voltage 120V
- Max. surge current: 90 A, 2/10  $\mu$ s

## TELEPHONE CALL TRANSFORMATOR WITH SURGE PROTECTION

1 EZ 003



Telephone ring signal switch on power supply: - signal light  
- horn (1EZ002)

### SPECIFICATIONS:

Power rating: voltage: 250 VAC  
current: 10/16 A  
Max. surge: voltage: 6000 V  
current: 4500 A  
Max. clamping voltage: 650 V  
Max. energy dissipation: 70J (L-N) + 70J (L-PE) + 70J (N-PE)

## ADDITIONAL HORN

1 EZ 002



### FEATURES:

Input voltage: 230 V 50 Hz  
Consumption: 15W ± 15%  
Loudness: 85 dB

## POWER SUPPLY

Power supply with voltage regulation  
3V to 12V / 350 mA

1 NA 010A

Power supply with voltage regulation  
3V to 12V / 750 mA

1 NA 010

Power supply (revers polarity)  
9V / 600 mA

1 NA 012

Power supply (revers polarity)  
12V / 600 mA

1 NA 020



## TELEPHONE CONVERSATION OF RECORDING INTERFACE

1 EA 052



### FEATURES:

This device enables recording  
and reproduction of telephone  
conversation

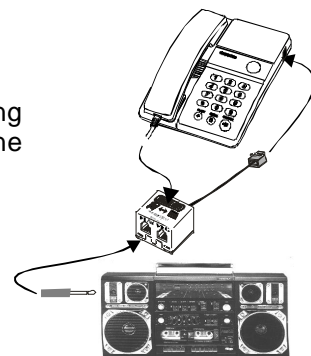

## CALLER ID 2008E

1 EA 001



### FEATURES:

- \* FSK / DTMF dual standard, 100 call memories, call back and auto long-distance call back
- \* Last 30 dialed number and conversation time review and redial
- \* 2 local area code setting
- \* Fast checking the incoming call including calling number and calling date & time
- \* 5 step LCD contrast adjustment
- \* Conversation time display

## TELE - RINGER WITH FLASH LAMP

1 EA 0033



### FEATURES:

- \* easy to connect to telephone in parallel with additional cord
- \* cords not included
- \* ON \ OFF switch

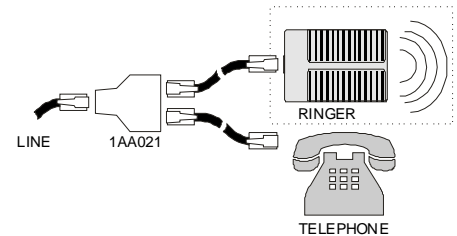

## MICROPHONE CARBON CAPSULES

1 RV 003



### FEATURES:

- \* compatible replacement for older microphones in analog telephones
- \* dynamic resistance: 50-115Ω

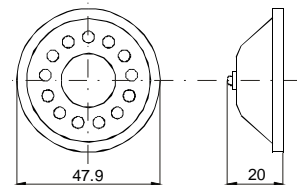

## DYNAMIC HANDSET SPEAKER

1 RV 006



### FEATURES:

- \* compatible replacement for older microphones in analog telephones
- \* Resistance = 150Ω

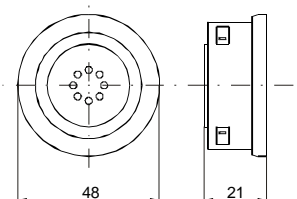

## TELEPHONE LINE CHECKER TLC-1 (POTS)

1 EA 050

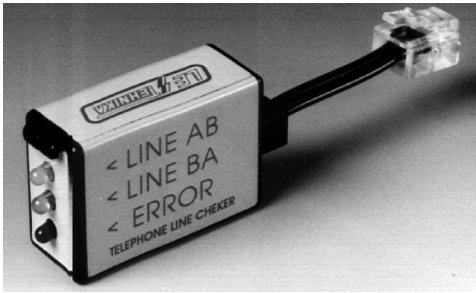

LIGHT	FUNCTION
None	no line connection
Red	current line < 20 mA
Green	O.K. line AB
Yellow	O.K. line BA
Red & Green	AB current > 60 mA
Red & Yellow	BA current > 60 mA

- \* Swiss Line tester: page 60
- \* German Line tester: page 52
- \* Austrian Line tester: page 38

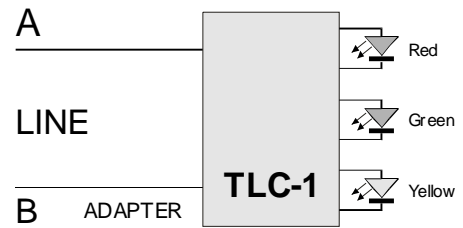

## ISDN LINE CHECKER

1 EA 065



- ISDN line tester shows the correctness of your ISDN S<sub>0</sub> bus line connections,
- Indication of the problem is presented with 4 LED.
- Combination of all four LED shows different states and working conditions of the ISDN S<sub>0</sub> bus.
- This tester uses the Phantom power - no need for additional power supply.

## SERVICE TELEPHONE (POTS)

1 TA 701



Environment: -10/+40°C , humidity < 95%  
 Weight: 0,48 Kg ( including package)  
 Protection withstands 180 Vdc and 50 mA (above PCM voltage)

Test Phone is self-powered, portable telephone test set which is suitable for installation, maintenance and repair of the terminal telecommunication equipment.

## AMPLIFIER PROBE & TONE GENERATOR KIT TCT - 470

1 RA 470



### AMPLIFIER PROBE & TONE GENERATOR KIT:

- The amplifier probe is designed to identify and trace wires or cables within a group without damaging the insulation.
- Works with any tone generator to identify wires.
- Volume control for increased sensitivity and adjustable to suit work environment.



## NET TONER & PROBE KIT TCT - 680

1 EA 680



### Net Probe:

- Composite tip reduces shock risk.
- Works with any tone generator.
- LED signals strength indication.
- Adjustable volume control.
- Earphone jack for noisy environments.
- Modular jacks and test pins for multiple connection options.
- Ring-tip polarity test indicator.
- Lanyard attachment point for hands-free operation.
- Easy tip replacement.
- Low battery indicator.

### Net Toner:

- Selectable dual tone outputs on twisted pair, Coax and bare wire for multiple line identification.
- Line1, Line2 polarity indicator for fast outlet identification and voltage detection.
- Continuity test on Lan, Telco, Coax and bare wires.
- Enhanced talk battery supply for communications over inactive pairs.
- Includes alligator clips, modular plug and jack for multiple connection options.
- Low battery indicator.

## UTP NETWORK CABLE TESTER

1 EA 560



### NETWORK CABLE TESTER:

- Check types 5, 5e and twisted cord network and trouble.
- Check cable sequence.
- Use TDR (time domain reflectometer), measure length and distance, find the trouble location.
- Find the determine open circuit, short circuit, jumper or crossfire.
- Service line test and no external adaptor is required.
- Determine continuity and wiring pattern.

## CABLE TESTER TCT - 141

1 EA 141



### CABLE TESTER:

- Easily read correct pin configuration of 10baseT, 10base2, RJ45 / RJ11 modular cables, 258A, TIA568A / 568B, token ring, etc.
- Test installed cables either on wall plate or patch panel from a distance.
- Check for cable continuity, miswiring, open, short, grounding and pin configurations.
- Cable adapters: RJ45 M-M, 2RJ45 M-BNCF, BNC M-M
- On-board connectors: 2 RJ45F (tester), 1 RJ45F (remote)

## KIT FOR TEST CABLE NETWORK WITH TOOLS

1 RA 370



### KIT CONTENTS:

- Multi-Network cable tester for RJ45 (UTP/STP) and BNC.
- Modular crimping tool.
- Adjustable impact punch down tool with 66 and 110 blades.
- Cable stripper & cutter.
- 30 piece RJ45 (8P8C) modular plugs.
- 30 piece RJ11 (6P6C) modular plugs.
- 24 piece color strain relief.
- Components pocket.
- Zipper vinyl case.

## TELEPHONE SWING ARM

1 RA 016



### FEATURES:

- \* Telephone is lifted 185 mm above the desktop
- \* Platform size: 205 mm x 280 mm
- \* Arm can be extended from 140 mm to 220 mm

### ASSEMBLING DATA

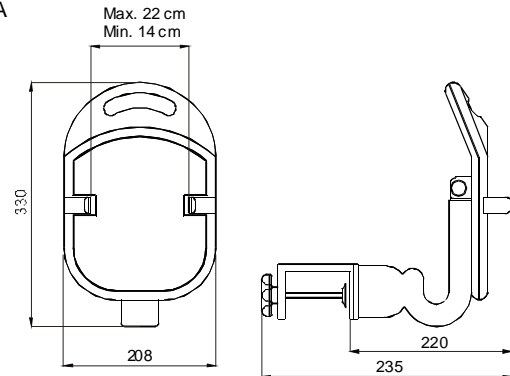

## MONITOR SWING ARM

1 RA 019



### FEATURES:

- \* Monitor platform size: 300 mm x 300 mm
- \* Holds up to 23 kg
- \* Lifts monitor from 150 mm to 200 mm above the desktop
- \* Clamps on up to 50 mm thick desktop
- \* Platform swivels 180 degrees and clamp rotates 360 degrees

### ASSEMBLING DATA

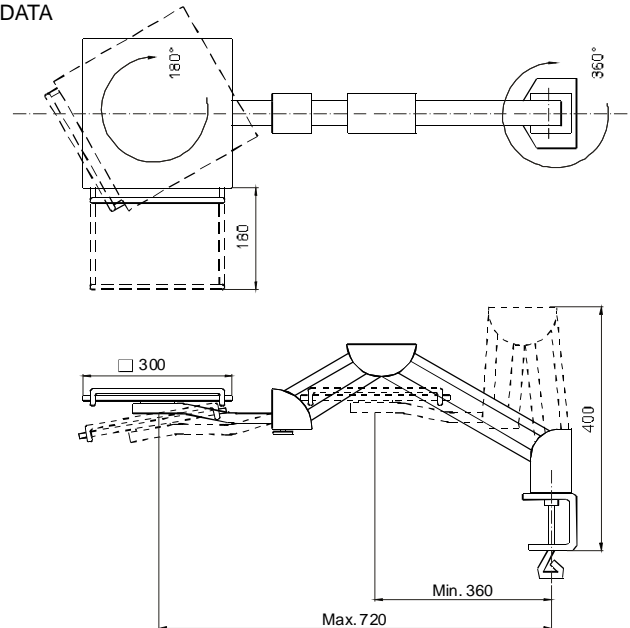

## MAGNIFYING GLASS WITH BUILT-IN LIGHT

1 RA 222



### MAGNIFYING GLASS:

- \* 5 x magnifying glass with built-in light.
- \* 45" (1143 mm) extension arm.
- \* Supplied with 22 watt circling fluorescent tube.
- \* New clamps design permits easy installation to bench.
- \* Connection: AC 220V

## EURO MAGIC BOX ( UNIVERSAL ADAPTER )

TABLE 1

Choose front / Choose back	K	J	H	G	E	D	C	B	A
A	AK	AJ	AH	AG	AE	AD	*AC	*AB	*AA
B	BK	BJ	BH	BG	BE	BD	*BC	*BB	
C	CK	CJ	CH	CG	CE	CD	CC		
D	DK	DJ	DH	DG	DE	DD			
E	EK	EJ	EH	EG	EE				
G	GK	GJ	GH	GG					
H	HK	HJ	HH						
J	JK	JJ							
K	KK								

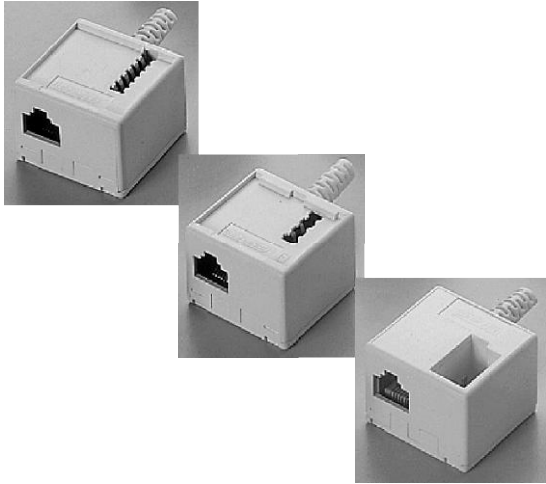

TABLE 2 ( Top side )

Right top / Left top	Tss	Tae-N	Tae-F	Tae-U	Ch	UK
Empty	0 1	0 2	0 3	0 4	0 5	0 6
Tss	1 1	1 2	1 3	1 4	1 5	1 6
Tae-N		2 2	2 3	2 4	2 5	2 6
Tae-F			3 3	3 4	3 5	3 6
Tae-U				4 4	4 5	4 6
Ch					5 5	5 6
UK						6 6

\* Different possibilities in table 2 which don't include combination zero (0).

TABLE 3 ( Contacts )

USED POSSIBLE	4	6	8	10
4	UX			
6	VX	VZ		
8	ZX	ZZ	ZV	
10	XX	XZ	XV	XU

### COLOUR

White = B
Black = C

WIRING DIAGRAM A1 - AUSTRIAN

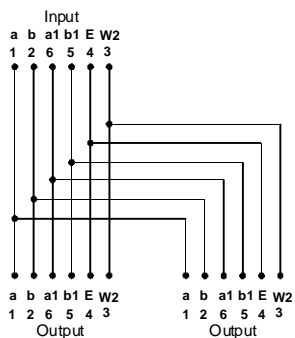

WIRING DIAGRAM C1 - SWISS

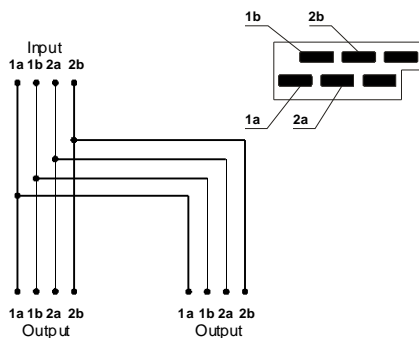

WIRING DIAGRAM D1 - GERMAN

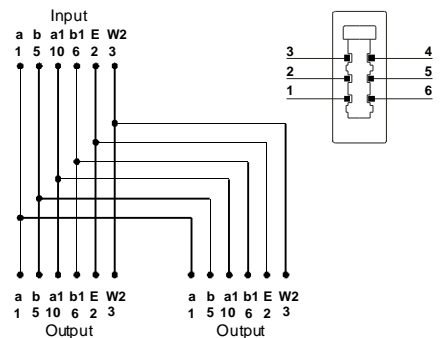

### CHOOSE CODE FOR EURO MAGIC BOX

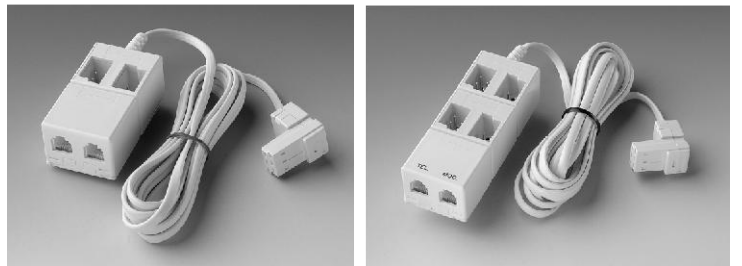
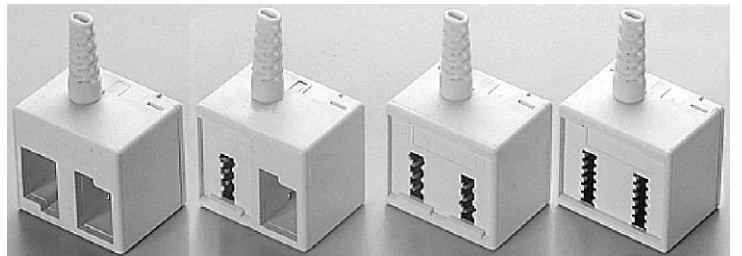
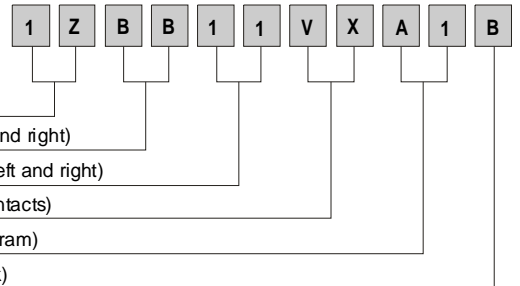

## EURO JACK



CODE		National jack	MODULAR JACK		
Flash mounting	Surface mounting				
1 DAA 100	1 DAA 110	3 cont.	—	—	—
1 DAA 101	1 DAA 111	3 cont.	—	6/3	—
1 DAA 102	1 DAA 112	3 cont.	6/3	—	6/3
1 DAA 103	1 DAA 113	3 cont.	6/3	6/3	6/3

\* Special order ( other colours possible )

### ASSEMBLING DATA

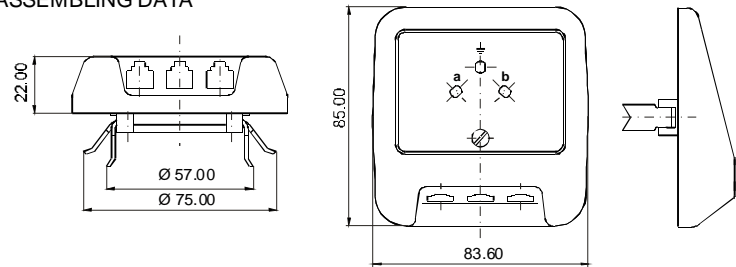

### WIRING DIAGRAM

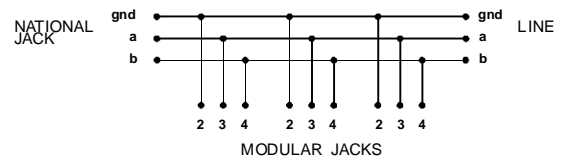

## WALL JACK



Flash mounting	Surface mounting	National jack	MODULAR JACK			Wiring diagram
1 DA 101	1 DA 111	3 cont.	—	6/3	—	1
1 DA 102	1 DA 112	3 cont.	6/3	—	6/3	1
1 DA 103	1 DA 113	3 cont.	6/3	6/3	6/3	1
1 DA 201	1 DA 211	—	—	6/3	—	1 without nat. jack
1 DA 202	1 DA 212	—	6/3	—	6/3	1 without nat. jack
1 DA 203	1 DA 213	—	6/3	6/3	6/3	1 without nat. jack
1 DA 301	1 DA 311	—	—	6/4	—	2 without nat. jack
1 DA 302	1 DA 312	—	6/4	—	6/4	2 without nat. jack

### ASSEMBLING DATA

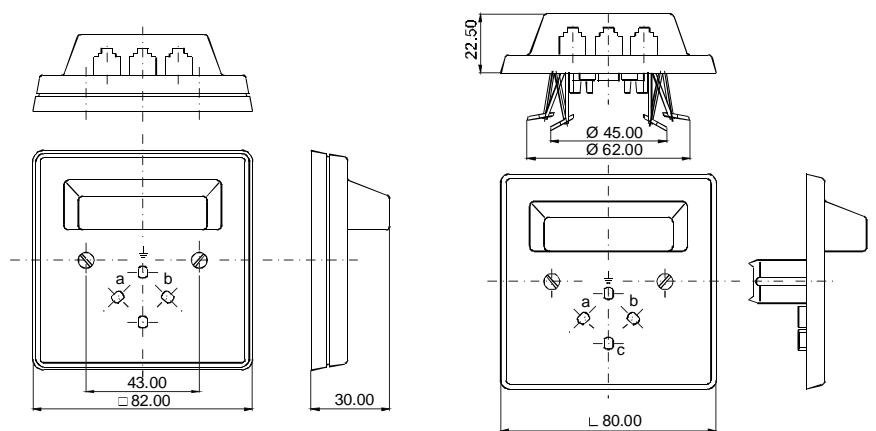

### WIRING DIAGRAM 1

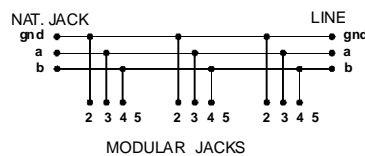

### WIRING DIAGRAM 2

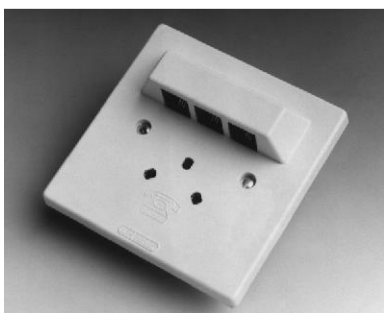
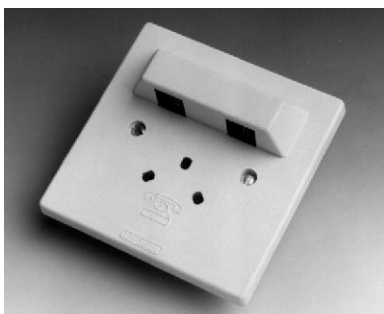
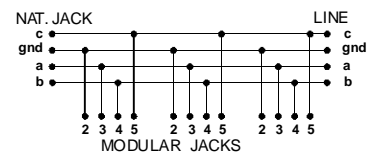

## PLUG

CODE	National plug	Colour
1 CA 001	3 cont.	black
1 CA 101	3 cont.	white

\* Special order ( other colours possible )

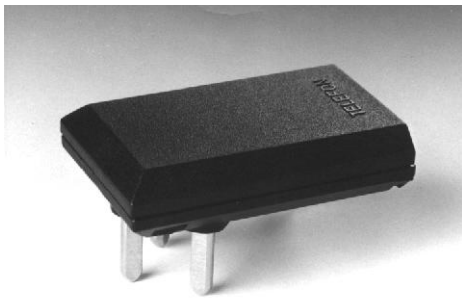

Plug is delivered in unassembled state.

### ASSEMBLING DATA

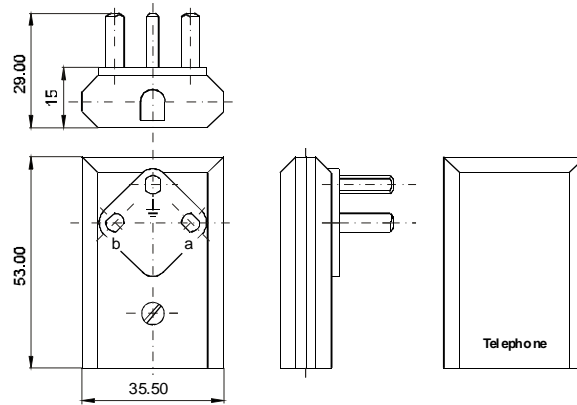

## COMBINED PLUGS AND ADAPTERS

CODE		Plug - number of contacts	Jack - number of contacts	Modular jack
Black	White			
1 AA 001	1 AA 101	3 cont.	3 cont.	6/3
1 AB 011	1 AB 111	3 cont.	—	6/3



### ASSEMBLING DATA

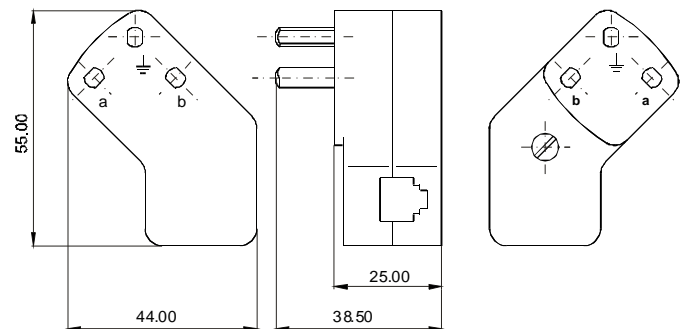

### WIRING DIAGRAM

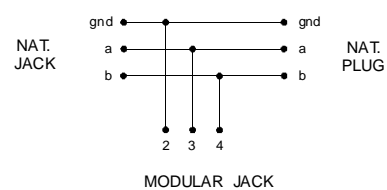

# SLO, CRO, BIH, SR, MAC TYPE



## COMBINED PLUGS AND ADAPTERS

CODE	Modular jack	National plug	National jack	Colour
1 AA 004	2 x 6/3	3 cont.	3 cont.	black
1 AA 104	2 x 6/3	3 cont.	3 cont.	white

\* Special order ( other colours possible )

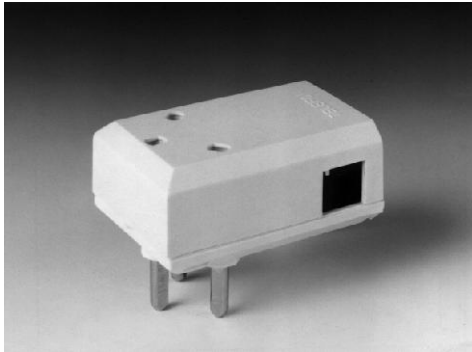

### ASSEMBLING DATA

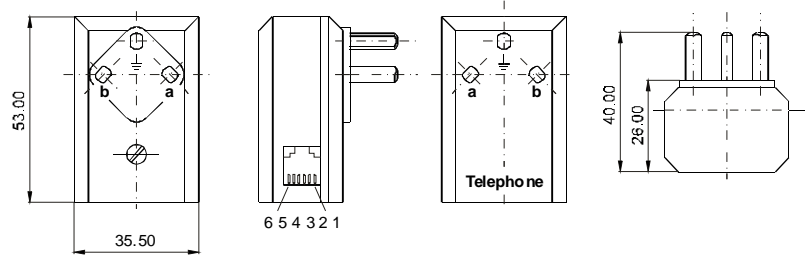

### WIRING DIAGRAM

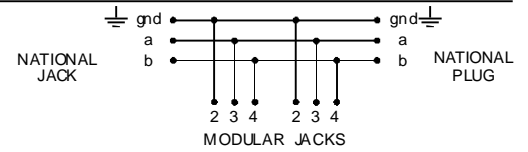

## ROUNDED ADAPTERS

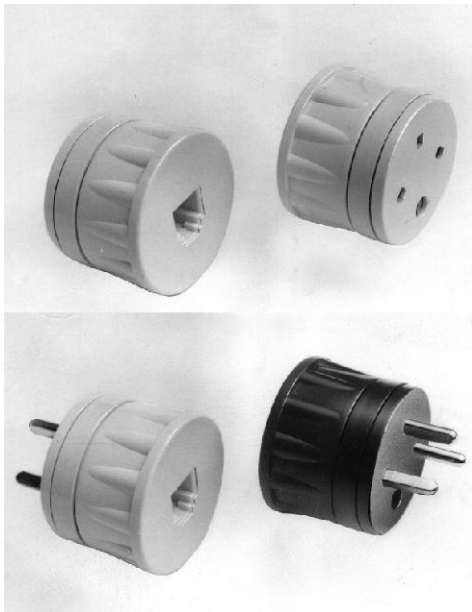

CODE	Modular jack	National plug	National jack	Colour
1 AA 010	6/3	-	3 cont.	black
1 AA 011	6/3	3 cont.	-	black
1 AA 110	6/3	-	3 cont.	white
1 AA 111	6/3	3 cont.	-	white

\* Special order ( other colours possible )

### ASSEMBLING DATA

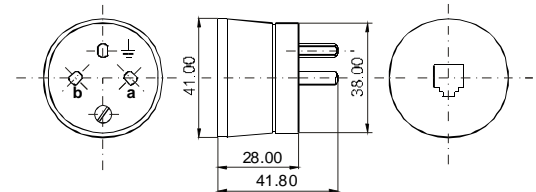

### WIRING DIAGRAM

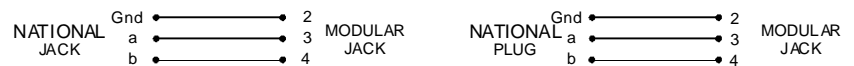

## COMBINED PLUG WITH AUTOMATIC TELEPHONE SWITCH

1 EA 002

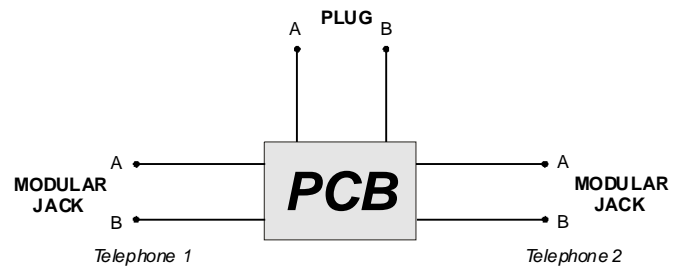

Lifting the handset of TELEPHONE 1 causes blocking of TELEPHONE 2 and vice - versa

## AUSTRIAN PLUG

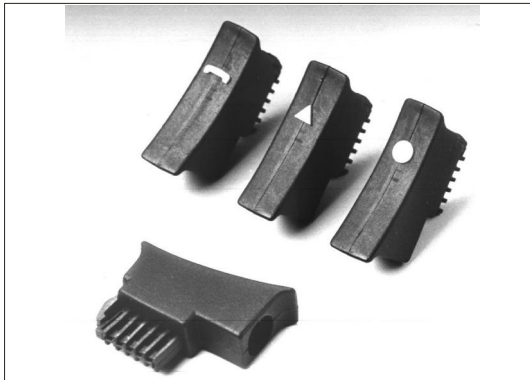

Symbol			Colour	Description
Telephone	Circle	Triangle		
1 CS 011	1 CS 012	1 CS 013	black	TSS-Plug without sleeve and contacts (just PVC p Cables)
1 CS 021	1 CS 022	1 CS 023	black	TSS-Plug with sleeve for flat cable and 6 contacts

### ASSEMBLING DATA

Plug is delivered in unassembled state.

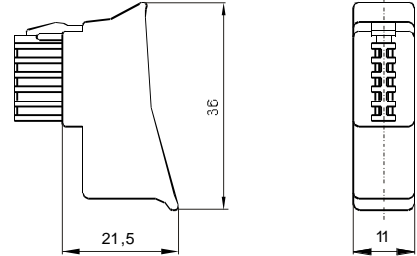

## CONTACTS FOR TAE AND TSS PLUG

CODE	Description
3 CS 001	Contacts for TSS and TAE Plug
3 CZ 001	Contacts for TSS and TAE Plug ( Gold platet)

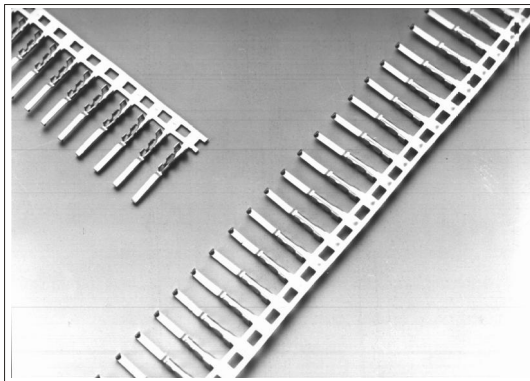

### ASSEMBLING DATA

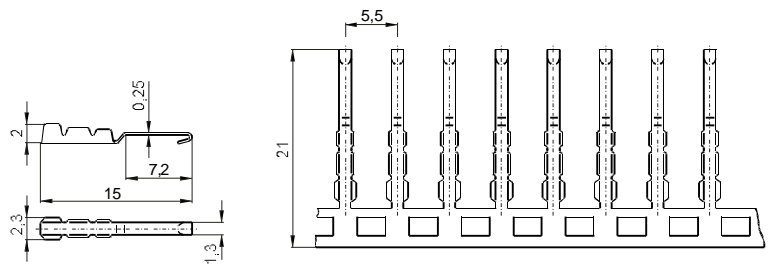

## MINI ADAPTER

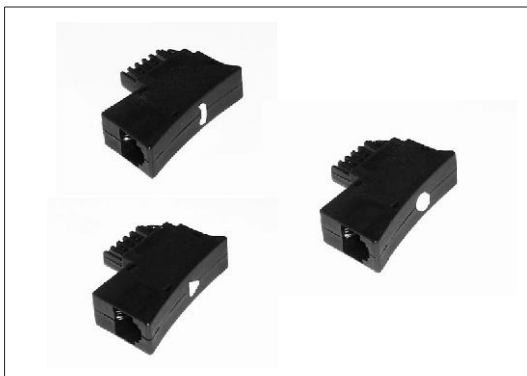

Symbol			Modular Jack	Colour	Viring
Telephone	Circle	Triangle			
1 ASM 050	1 ASM 059	1 ASM 060	6/2	black	1
1 ASM 057	1 ASM 052	1 ASM 051	6/2	black	2
1 ASM 056	1 ASM 053	1 ASM 058	6/4	black	3
1 ASM 061	1 ASM 062	1 ASM 054	6/4	black	4
1 ASM 063	1 ASM 064	1 ASM 055	6/6	black	5

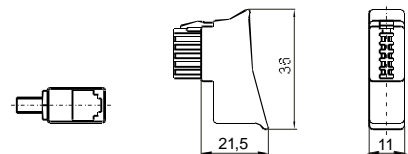

Wiring diagram 1

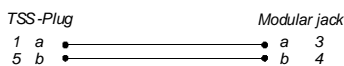

Wiring diagram 2

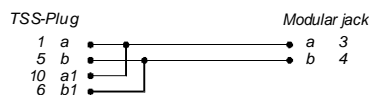

Wiring diagram 3

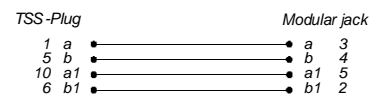

Wiring diagram 4

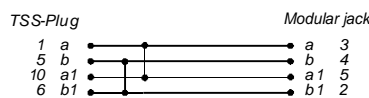

Wiring diagram 5

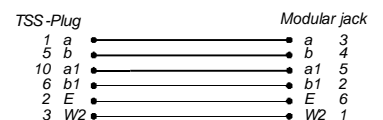

## COMBINED ADAPTER TSS / TSS / MODULAR JACK

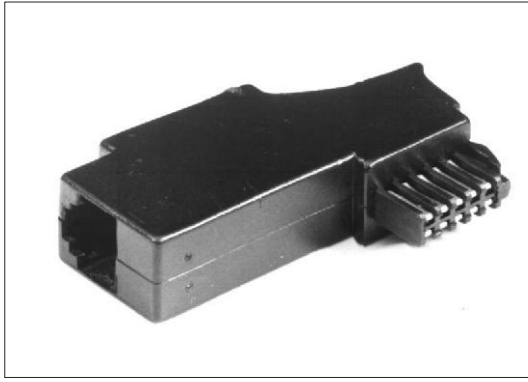

COMBINED PLUG TSS - TSS		
CODE	Type	Wiring diagram
1 AS 072	2 - cond.	1
1 AS 074	4 - cond.	2
1 AS 075	4 - cond.	3
1 AS 076	6 - cond.	4

### ASSEMBLING DATA

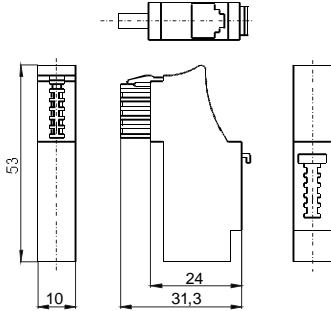

Wiring diagram 1

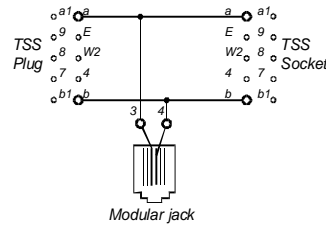

Wiring diagram 2

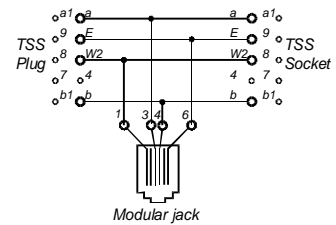

Wiring diagram 3

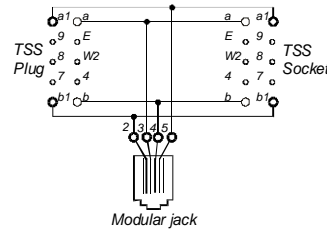

Wiring diagram 4

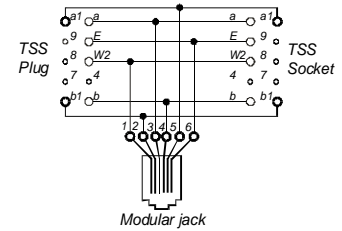

## COMBINED ADAPTER TSS / TAE / MODULAR JACK

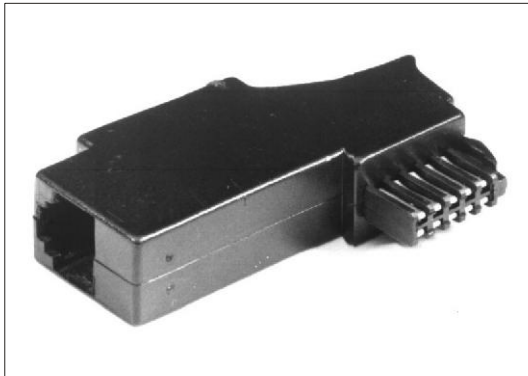

COMBINED ADAPTER TSS - TAE		
CODE	Type	Wiring diagram
1 AS 084	4 - cond.	1
1 AS 085	4 - cond.	2
1 AS 086	6 - cond.	3

### ASSEMBLING DATA

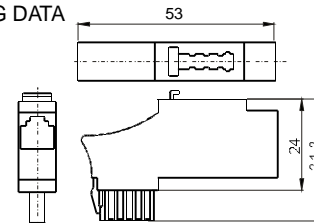

Wiring diagram 1

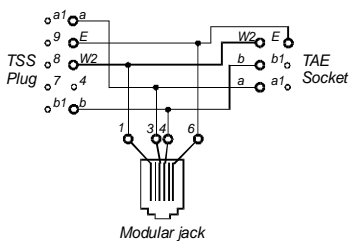

Wiring diagram 2

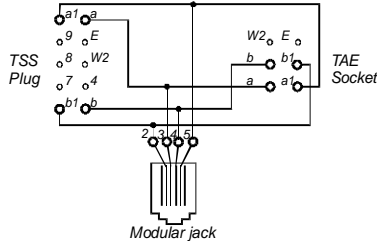

Wiring diagram 3

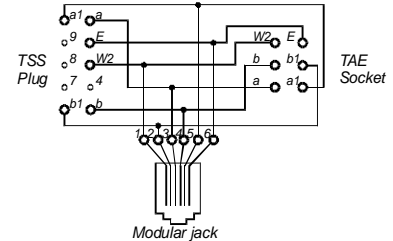

## TSS - LINE TESTER

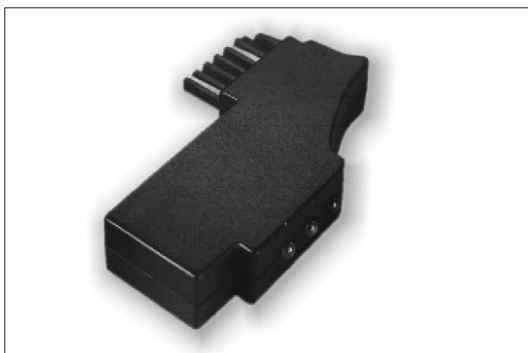

LED	FUNCTION
NOTING	NO Signal
RED	Curent < 20 mA
GREEN	O.K. Line AB
YELLOW	O.K. Line BA
RED+ GREEN	AB > 60 mA
RED+ YELLOW	BA > 60 mA

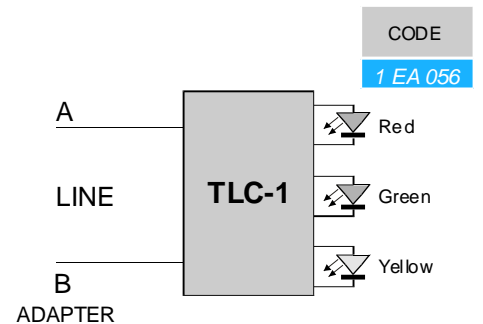



## EXTENSION CORDS - ADAPTER

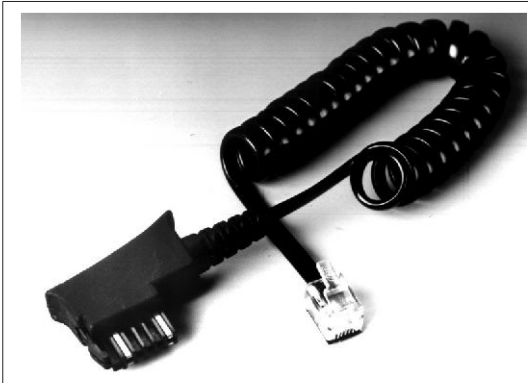
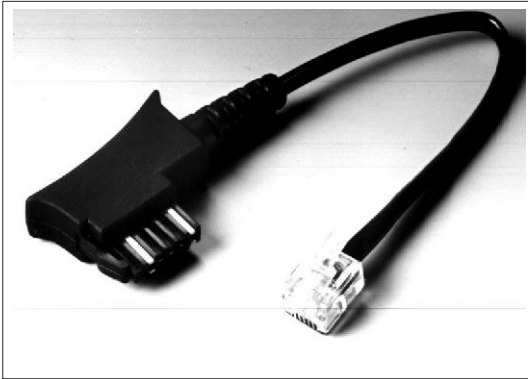

Symbol			Extension cord	Cable	Colour	Modular jack	Wiring diagram
Telephone	Circle	Triangle					
1 WA A03	1 WB A03	1 WC A03	3m	flat, 2-cond.	black	6/2	1
1 WA A06	1 WB A06	1 WC A06	6m	flat, 2-cond.	black	6/2	1
1 WA A10	1 WB A10	1 WC A10	10m	flat, 2-cond.	black	6/2	1
1 WA B03	1 WB B03	1 WC B03	3m	flat, 2-cond.	black	6/2	2
1 WA B06	1 WB B06	1 WC B06	6m	flat, 2-cond.	black	6/2	2
1 WA B10	1 WB B10	1 WC B10	10m	flat, 2-cond.	black	6/2	2
1 WA G03	1 WB G03	1 WC G03	3m	flat, 4-cond.	black	6/4	3
1 WA G06	1 WB G06	1 WC G06	6m	flat, 4-cond.	black	6/4	3
1 WA G10	1 WB G10	1 WC G10	10m	flat, 4-cond.	black	6/4	3
1 WA V03	1 WB V03	1 WC V03	3m	flat, 4-cond.	black	6/4	4
1 WA V06	1 WB V06	1 WC V06	6m	flat, 4-cond.	black	6/4	4
1 WA V10	1 WB V10	1 WC V10	10m	flat, 4-cond.	black	6/4	4
1 WA I03	1 WB I03	1 WC I03	3m	flat, 4-cond.	black	6/4	5
1 WA I06	1 WB I06	1 WC I06	6m	flat, 4-cond.	black	6/4	5
1 WA I10	1 WB I10	1 WC I10	10m	flat, 4-cond.	black	6/4	5
1 WA P03	1 WB P03	1 WC P03	3m	flat, 6-cond.	black	6/6	6
1 WA P06	1 WB P06	1 WC P06	6m	flat, 6-cond.	black	6/6	6
1 WA P10	1 WB P10	1 WC P10	10m	flat, 6-cond.	black	6/6	6
1 OA A03	1 OB A03	1 OC A03	3m	spiral, 2-cond.	black	6/2	1
1 OA A06	1 OB A06	1 OC A06	6m	spiral, 2-cond.	black	6/2	1
1 OA B03	1 OB B03	1 OC B03	3m	spiral, 2-cond.	black	6/2	2
1 OA B06	1 OB B06	1 OC B06	6m	spiral, 2-cond.	black	6/2	2
1 OA G03	1 OB G03	1 OC G03	3m	spiral, 4-cond.	black	6/4	3
1 OA G06	1 OB G06	1 OC G06	6m	spiral, 4-cond.	black	6/4	3
1 OA V03	1 OB V03	1 OC V03	3m	spiral, 4-cond.	black	6/4	4
1 OA V06	1 OB V06	1 OC V06	6m	spiral, 4-cond.	black	6/4	4
1 OA I03	1 OB I03	1 OC I03	3m	spiral, 4-cond.	black	6/4	5
1 OA I06	1 OB I06	1 OC I06	6m	spiral, 4-cond.	black	6/4	5
1 OA P03	1 OB P03	1 OC P03	3m	spiral, 6-cond.	black	6/6	6
1 OA P06	1 OB P06	1 OC P06	6m	spiral, 6-cond.	black	6/6	6

Wiring diagram 1

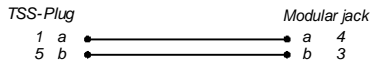

Wiring diagram 2

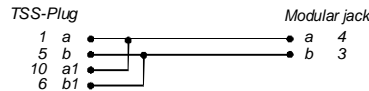

Wiring diagram 3

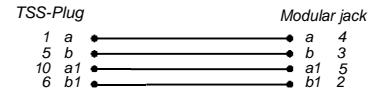

Wiring diagram 4

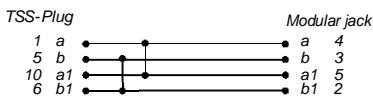

Wiring diagram 5

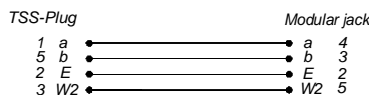

Wiring diagram 6

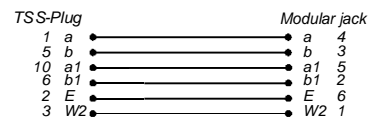

## MODULAR COUPLER TSS / MODULAR SOCKET



CODE	Cable	Colour	Modular jack	Wiring diagram
1 AK 021	flat, 2 conduct.	Black	6/2	1
1 AK 022	flat, 4 conduct.	Black	6/4	2
1 AK 023	flat, 4 conduct.	Black	6/4	3
1 AK 024	flat, 6 conduct.	Black	6/6	4

Wiring diagram 1

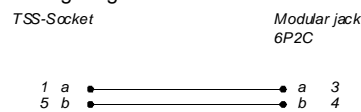

Wiring diagram 2

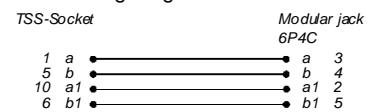

Wiring diagram 3

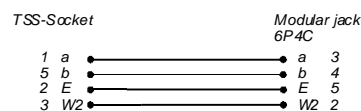

Wiring diagram 4

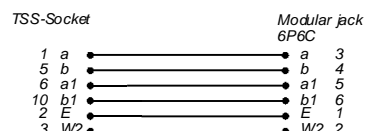

### ASSEMBLING DATA

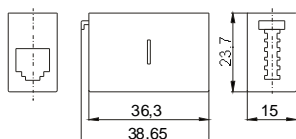

## EXTENSION CORDS - ADAPTER

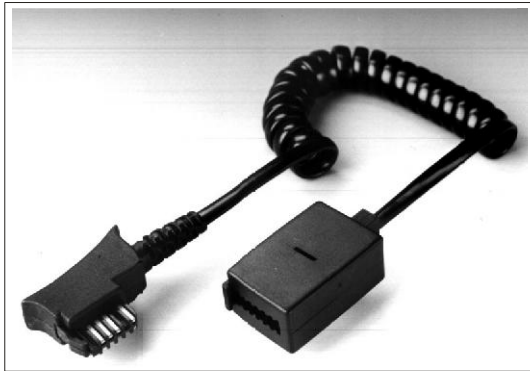
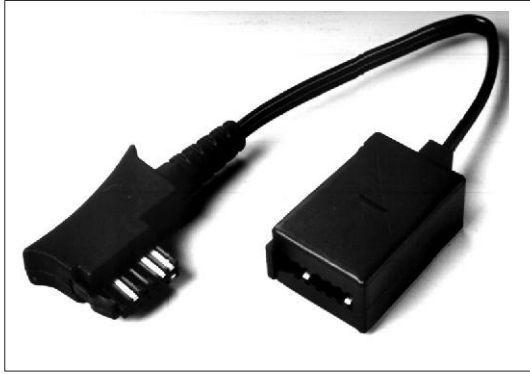

Symbol			Cable	Type	Colour	TAE Socket	Wiring
Telephone	Circle	Triangle					
1 WS A03	1 WT A03	1 WU A03	3m	flat,2-cond.	black	2-polig	1
1 WS A06	1 WT A06	1 WU A06	6m	flat,2-cond.	black	2-polig	1
1 WS A10	1 WT A10	1 WU A10	10m	flat,2-cond.	black	2-polig	1
1 WS B03	1 WT B03	1 WU B03	3m	flat,2-cond.	black	2-polig	2
1 WS B06	1 WT B06	1 WU B06	6m	flat,2-cond.	black	2-polig	2
1 WS B10	1 WT B10	1 WU B10	10m	flat,2-cond.	black	2-polig	2
1 WS G03	1 WT G03	1 WU G03	3m	flat,4-cond.	black	4-polig	3
1 WS G06	1 WT G06	1 WU G06	6m	flat,4-cond.	black	4-polig	3
1 WS G10	1 WT G10	1 WU G10	10m	flat,4-cond.	black	4-polig	3
1 WS M03	1 WT M03	1 WU M03	3m	flat,6-cond.	black	6-polig	4
1 WS M06	1 WT M06	1 WU M06	6m	flat,6-cond.	black	6-polig	4
1 WS M10	1 WT M10	1 WU M10	10m	flat,6-cond.	black	6-polig	4
1 OS A03	1 OT A03	1 OU A03	3m	spiral,2-cond.	black	2-polig	1
1 OS A06	1 OT A06	1 OU A06	6m	spiral,2-cond.	black	2-polig	1
1 OS B03	1 OT B03	1 OU B03	3m	spiral,2-cond.	black	2-polig	2
1 OS B06	1 OT B06	1 OU B06	6m	spiral,2-cond.	black	2-polig	2
1 OS G03	1 OT G03	1 OU G03	3m	spiral,4-cond.	black	4-polig	3
1 OS G06	1 OT G06	1 OU G06	6m	spiral,4-cond.	black	4-polig	3
1 OS M03	1 OT M03	1 OU M03	3m	spiral,6-cond.	black	6-polig	4
1 OS M06	1 OT M06	1 OU M06	6m	spiral,6-cond.	black	6-polig	4

Wiring diagram 1

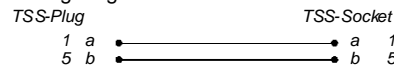

Wiring diagram 2

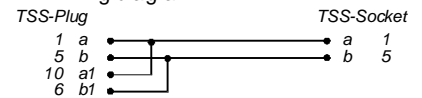

Wiring diagram 3

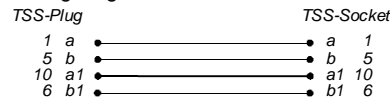

Wiring diagram 4

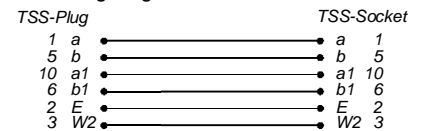

## EXTENSION CORDS - ADAPTER



Symbol			Cable	Type	Colour	Wiring
Telephone	Circle	Triangle				
1 WS Y71	1 WT Y71	1 WU Y71	10cm	flat,2-cond.	black	1
1 WS Z71	1 WT Z71	1 WU Z71	10cm	flat,2-cond.	black	2
1 WS U71	1 WT U71	1 WU U71	10cm	flat,4-cond.	black	3
1 WS V71	1 WT V71	1 WU V71	10cm	flat,4-cond.	black	4
1 WS X71	1 WT X71	1 WU X71	10cm	flat,2-cond.	black	5

Wiring diagram 1

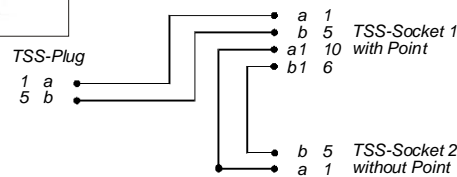

Wiring diagram 2

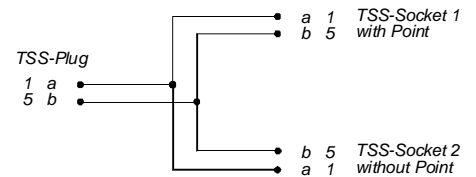

Wiring diagram 3

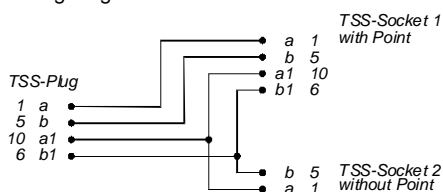

Wiring diagram 4

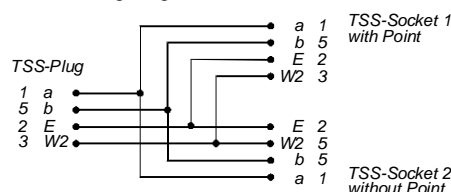

Wiring diagram 5

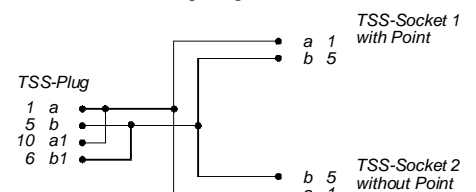

## EXTENSION CORDS - ADAPTER

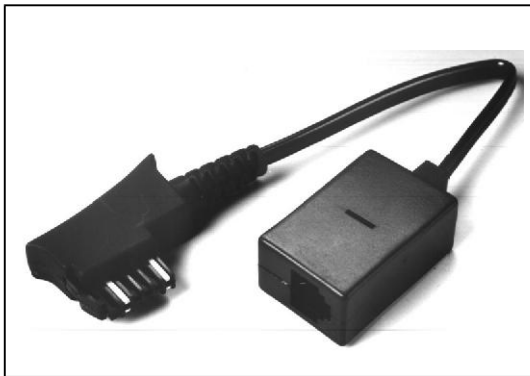

Symbol			Cable	Type	Colour	Modular Jack	Wiring
Telephone	Circle	Triangle					
1 WP A03	1 WQ A03	1 WR A03	3m	flat,2-cond.	black	6/2	1
1 WP A06	1 WQ A06	1 WR A06	6m	flat,2-cond.	black	6/2	1
1 WP A10	1 WQ A10	1 WR A10	10m	flat,2-cond.	black	6/2	1
1 WP B03	1 WQ B03	1 WR B03	3m	flat,2-cond.	black	6/2	2
1 WP B06	1 WQ B06	1 WR B06	6m	flat,2-cond.	black	6/2	2
1 WP B10	1 WQ B10	1 WR B10	10m	flat,2-cond.	black	6/2	2
1 WP G03	1 WQ G03	1 WR G03	3m	flat,4-cond.	black	6/4	3
1 WP G06	1 WQ G06	1 WR G06	6m	flat,4-cond.	black	6/4	3
1 WP G10	1 WQ G10	1 WR G10	10m	flat,4-cond.	black	6/4	3
1 WP V03	1 WQ V03	1 WR V03	3m	flat,4-cond.	black	6/4	4
1 WP V06	1 WQ V06	1 WR V06	6m	flat,4-cond.	black	6/4	4
1 WP V10	1 WQ V10	1 WR V10	10m	flat,4-cond.	black	6/4	4
1 OP I03	1 OQ I03	1 OR I03	3m	spiral,4-cond.	black	6/4	5
1 OP I06	1 OQ I06	1 OR I06	6m	spiral,4-cond.	black	6/4	5
1 OP I10	1 OQ I10	1 OR I10	10m	spiral,4-cond.	black	6/4	5
1 OP P03	1 OQ P03	1 OR P03	3m	spiral,6-cond.	black	6/6	6
1 OP P06	1 OQ P06	1 OR P06	6m	spiral,6-cond.	black	6/6	6
1 OP P10	1 OQ P10	1 OR P10	10m	spiral,6-cond.	black	6/6	6

Wiring diagram 1

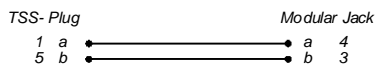

Wiring diagram 2

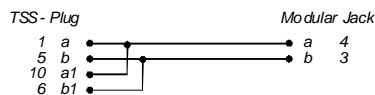

Wiring diagram 3

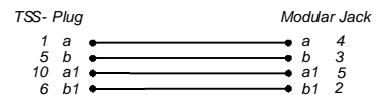

Wiring diagram 4

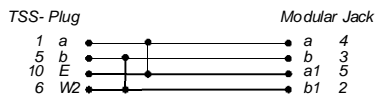

Wiring diagram 5

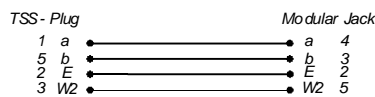

Wiring diagram 6

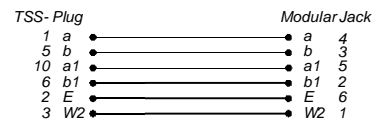

## EXTENSION CORDS - ADAPTER

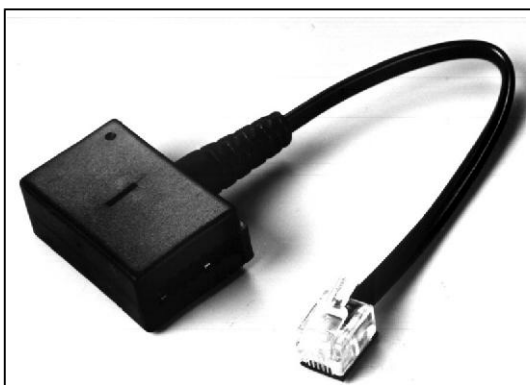

CODE	Cable	Type	Colour	Modular plug	Wiring
1 US A71	10cm	flat,2-cond.	black	6/2	1
1 US B71	10cm	flat,2-cond.	black	6/2	2
1 US H71	10cm	flat,4-cond.	black	6/4	3
1 US M71	10cm	flat,4-cond.	black	6/4	4

Wiring diagram 1

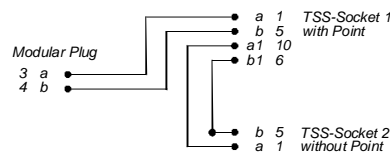

Wiring diagram 2

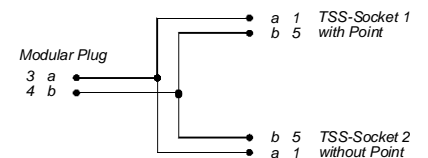

Wiring diagram 3

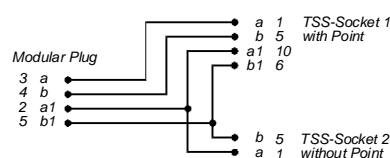

Wiring diagram 4

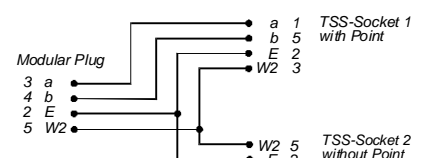

## EXTENSION CORDS - ADAPTER TSS Plug/TAE Socket

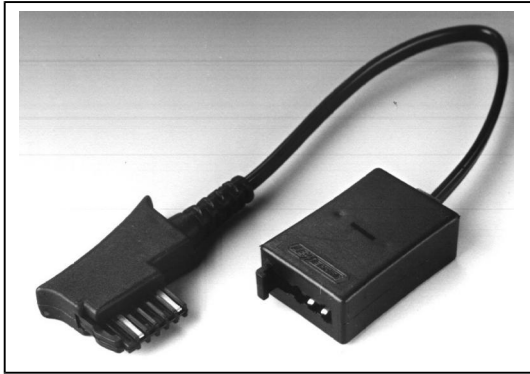

Position of contacts :  
German Socket

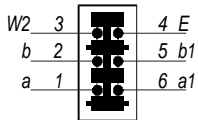

Symbol			Cable	Type	Colour	TAE Socket	Wiring
Telephone	Circle	Triangle					
1 WW A03	1 WV A03	1 WX A03	3m	flat,2-cond.	black	2-polig	1
1 WW A06	1 WV A06	1 WX A06	6m	flat,2-cond.	black	2-polig	1
1 WW A10	1 WV A10	1 WX A10	10m	flat,2-cond.	black	2-polig	1
1 WW A71	1 WV A71	1 WX A71	10cm	flat,2-cond.	black	2-polig	1
1 WW B03	1 WV B03	1 WX B03	3m	flat,2-cond.	black	2-polig	2
1 WW B06	1 WV B06	1 WX B06	6m	flat,2-cond.	black	2-polig	2
1 WW B10	1 WV B10	1 WX B10	10m	flat,2-cond.	black	2-polig	2
1 WW B71	1 WV B71	1 WX B71	10cm	flat,2-cond.	black	2-polig	2
1 WW G03	1 WV G03	1 WX G03	3m	flat,4-cond.	black	4-polig	3
1 WW G06	1 WV G06	1 WX G06	6m	flat,4-cond.	black	4-polig	3
1 WW G10	1 WV G10	1 WX G10	10m	flat,4-cond.	black	4-polig	3
1 WW G71	1 WV G71	1 WX G71	10cm	flat,4-cond.	black	4-polig	3
1 WW M03	1 WV M03	1 WX M03	3m	flat,6-cond.	black	6-polig	4
1 WW M06	1 WV M06	1 WX M06	6m	flat,6-cond.	black	6-polig	4
1 WW M10	1 WV M10	1 WX M10	10m	flat,6-cond.	black	6-polig	4
1 WW M71	1 WV M71	1 WX M71	10cm	flat,6-cond.	black	6-polig	4

Wiring diagram 1

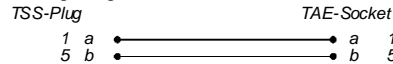

Wiring diagram 2

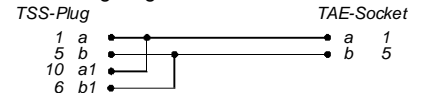

Wiring diagram 3

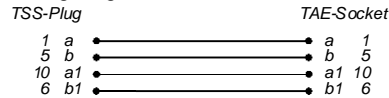

Wiring diagram 4

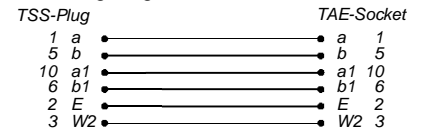

## EXTENSION CORDS - ADAPTER

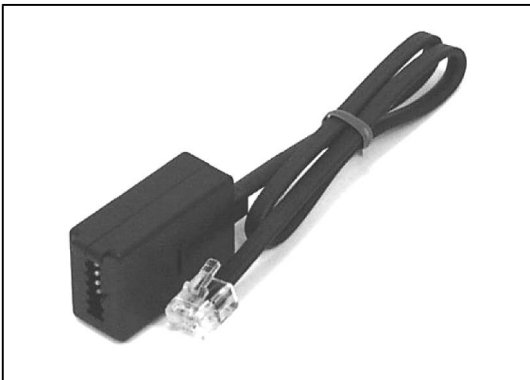

CODE	Cable	Type	Colour	TSS Socket	Wiring
1 UA G03	3m	flat,4-cond.	black	6/4	1
1 UA G06	6m	flat,4-cond.	black	6/4	1
1 UA G10	10m	flat,4-cond.	black	6/4	1
1 UA G71	10cm	flat,4-cond.	black	6/4	1
1 UA A03	3m	flat,2-cond.	black	6/2	2
1 UA A06	6m	flat,2-cond.	black	6/2	2
1 UA A10	10m	flat,2-cond.	black	6/2	2
1 UA A71	10cm	flat,2-cond.	black	6/2	2

Wiring diagram 1

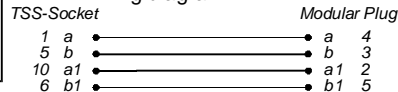

Wiring diagram 2

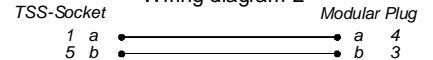

## EXTENSION CORDS - ADAPTER



Symbol			Cable	Type	Colour	Modular Plug
Telephone	Circle	Triangle				
1 WZAG03	1 WZBG03	1 WZCG03	3m	flat,4-co.nd.	black	6/2
1 WZAG06	1 WZBG06	1 WZCG06	6m	flat,4-co.nd.	black	6/2
1 WZAG10	1 WZBG10	1 WZCG10	10m	flat,4-co.nd.	black	6/2
1 WZAG88	1 WZBG88	1 WZCG88	1,8m	flat,4-co.nd.	black	6/2

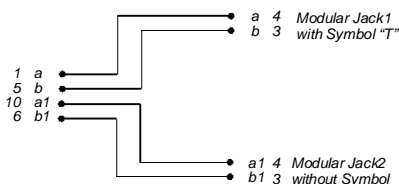

## EURO JACK

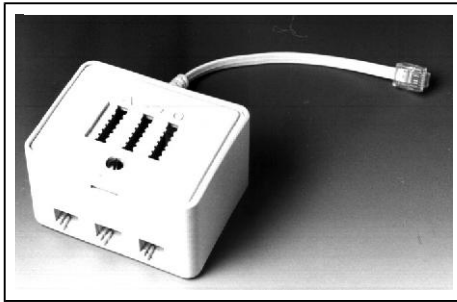
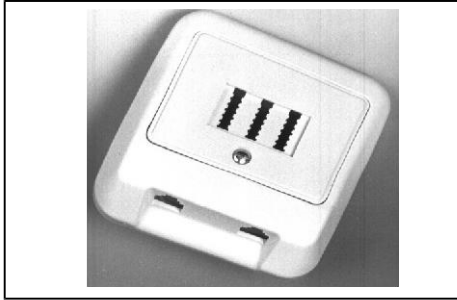

Wiring diagram 1

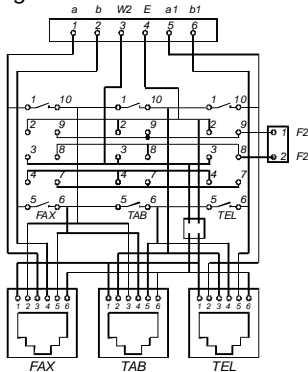

Wiring diagram 2

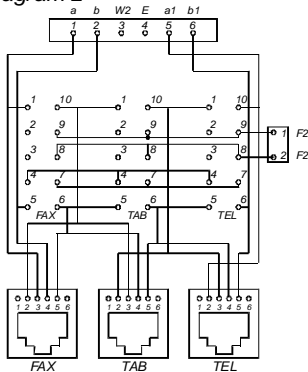

CODE	TSS Socket	Modular Jack	Colour	Wiring diagram	Flash/Surface mounting
1 DS A300	3	0	White	1	Flash
1 DS A301	3	1X6/4	White	1	Flash
1 DS A302	3	1X6/4 + 1X6/6	White	1	Flash
1 DS A303	3	2X6/4 + 1X6/6	White	1	Flash
1 DS A101	1	1X6/4	White	1	Flash
1 DS A102	1	1X6/4 + 1X6/6	White	1	Flash
1 DS A103	1	2X6/4 + 1X6/6	White	1	Flash
1 DS A310	3	0	White	1	Surface
1 DS A311	3	1X6/4	White	1	Surface
1 DS A312	3	1X6/4 + 1X6/6	White	1	Surface
1 DS A313	3	2X6/4 + 1X6/6	White	1	Surface
1 DS A111	1	1X6/4	White	1	Surface
1 DS A112	1	1X6/4 + 1X6/6	White	1	Surface
1 DS A113	1	2X6/4 + 1X6/6	White	1	Surface
1 DS B300	3	0	White	2	Flash
1 DS B301	3	1X6/4	White	2	Flash
1 DS B302	3	2X6/4	White	2	Flash
1 DS B303	3	3X6/4	White	2	Flash
1 DS B101	1	1X6/4	White	2	Flash
1 DS B102	1	2X6/4	White	2	Flash
1 DS B103	1	3X6/4	White	2	Flash
1 DS B310	3	0	White	2	Surface
1 DS B311	3	1X6/4	White	2	Surface
1 DS B312	3	2X6/4	White	2	Surface
1 DS B313	3	3X6/4	White	2	Surface
1 DS B111	1	1X6/4	White	2	Surface
1 DS B112	1	2X6/4	White	2	Surface
1 DS B113	1	3X6/4	White	2	Surface
1 DSAV300	3	0	White	1	Socket
1 DSAV303	3	2X6/4 + 1X6/6	White	1	Socket
1 DSAV003	0	2X6/4 + 1X6/6	White	1	Socket
1 DSBV300	3	0	White	2	Socket
1 DSBV303	3	3X6/4	White	2	Socket
1 DSBV003	0	3X6/4	White	2	Socket

\* Special order (other colours possible)

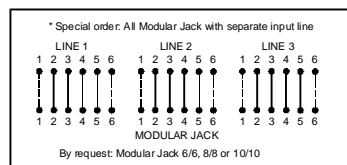

## ASSEMBLING DATA

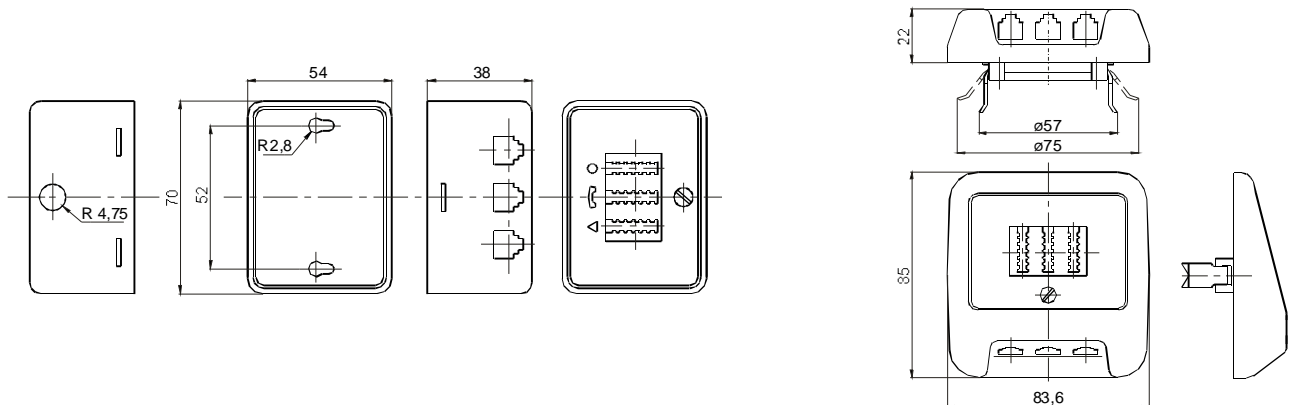

## TSS / TAE ADAPTER

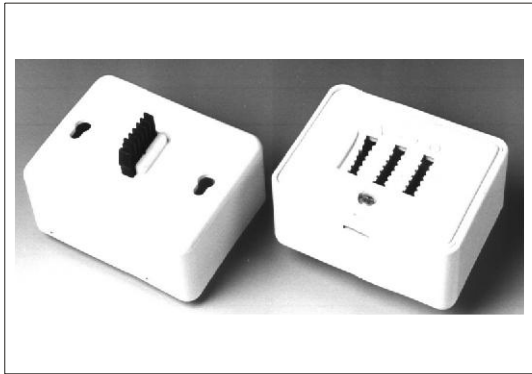

CODE	Jack	Plug	Wiring diagram
1 AS 031	3 X TSS	TSS	1
1 AS 035	3 X TSS	TAE	2
1 AN 035	3 X TAE	TSS	3

### ASSEMBLING DATA

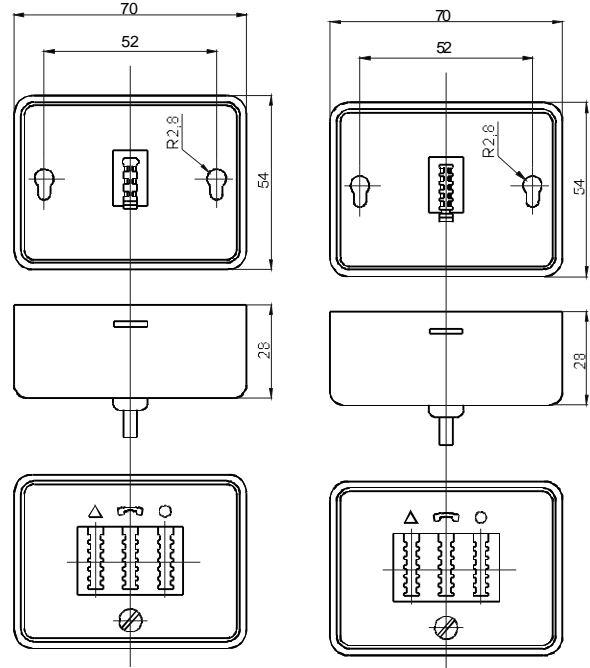

Wiring diagram 1

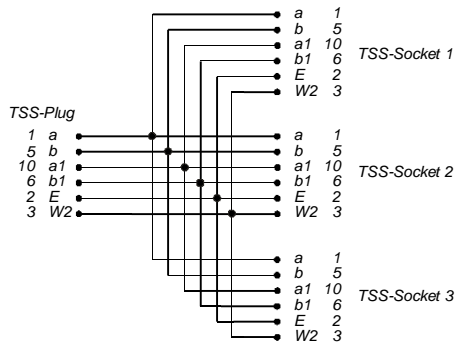

Wiring diagram 2

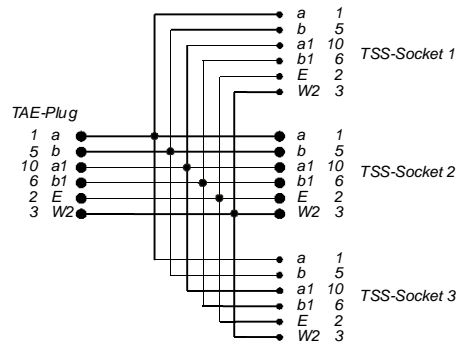

Wiring diagram 3

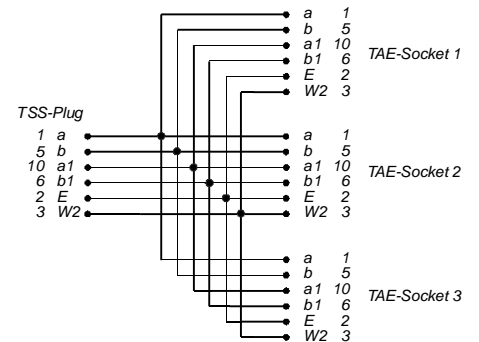

## TAE PLUG

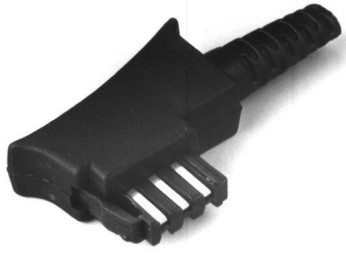

CODE			Colour	Description
F	N	U		
1 CN 011	1 CN 012	1 CN 013	black	TAE-Plug without sleeve and contacts (only PVC parts)
1 CN 021	1 CN 022	1 CN 023	black	TAE-Plug with sleeve for flat cable and 6 contacts

### ASSEMBLING DATA

Plug is delivered in unassembled state.

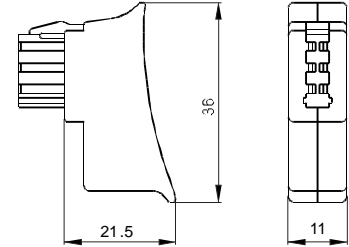

## CONTACTS FOR TAE AND TSS PLUG

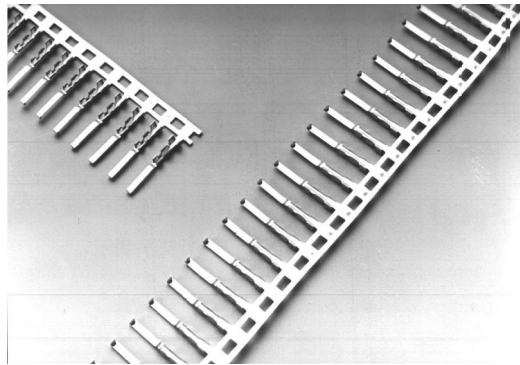

CODE	Description
3 CS 001	Contacts for TSS or TAE plug
3 CZ 001	Contacts for TSS or TAE plug - (gold plated)

### ASSEMBLING DATA

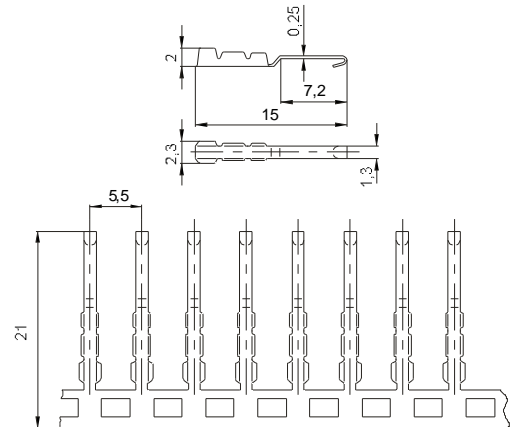

## TAE - WB ADAPTER



Plug - Type			Modular socket	Colour	Wiring diagram
F	N	U			
1 ANM050	1 ANM056	1 ANM057	6/2	black	1
1 ANM058	1 ANM051	1 ANM059	6/2	black	2
	1 ANM052	1 ANM061	6/4	black	3
1 ANM068		1 ANM070	6/4	black	4
1 ANM054		1 ANM065	6/4	black	5
	1 ANM055	1 ANM067	6/6	black	6

### ASSEMBLING DATA

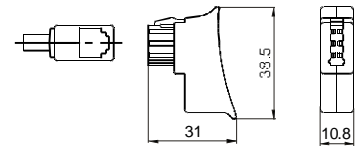

Wiring diagram 1

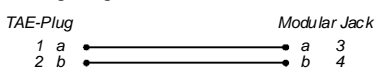

Wiring diagram 2

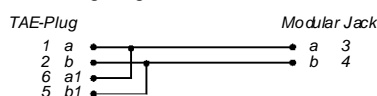

Wiring diagram 3

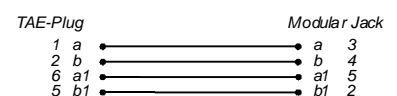

Wiring diagram 4

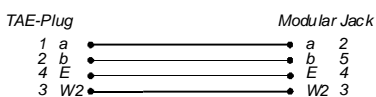

Wiring diagram 5

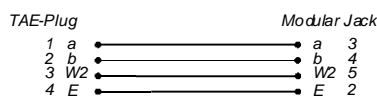

Wiring diagram 6

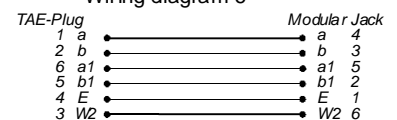

## COMBINED TAE-TAE-WB ADAPTER

Combined Plug TAE - TAE - WB		
CODE	Cable	Wiring diagram
1 AN 072	2 - cond.	1
1 AN 074	4 - cond.	2
1 AN 075	4 - cond.	3
1 AN 076	6 - cond.	4

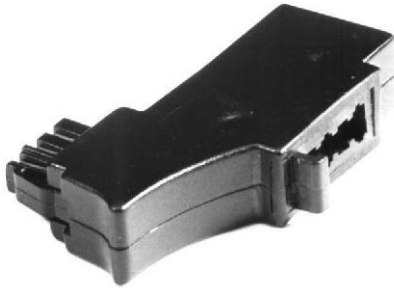

### ASSEMBLING DATA

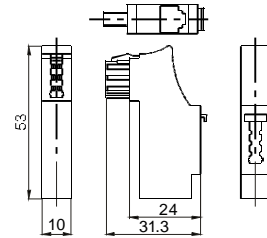

Wiring diagram 1

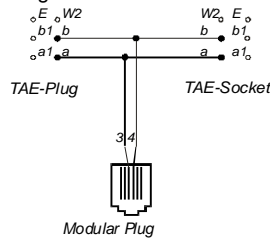

Wiring diagram 2

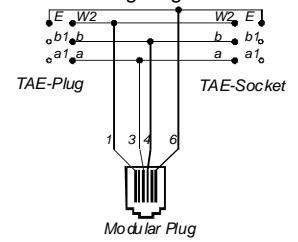

Wiring diagram 3

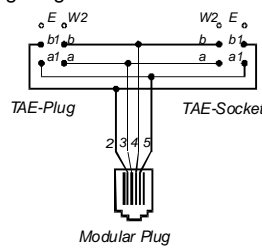

Wiring diagram 4

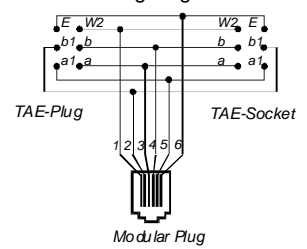

## COMBINED TAE-TSS-WB ADAPTER

Combined Plug TAE - TSS - WB		
CODE	Cable	Wiring diagram
1 AN 084	4 - cond.	1
1 AN 085	4 - cond.	2
1 AN 086	6 - cond.	3

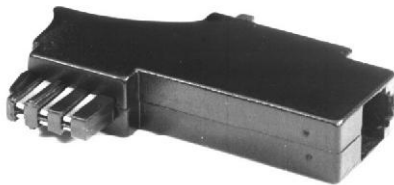

### ASSEMBLING DATA

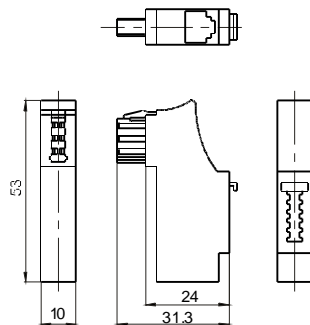

Wiring diagram 1

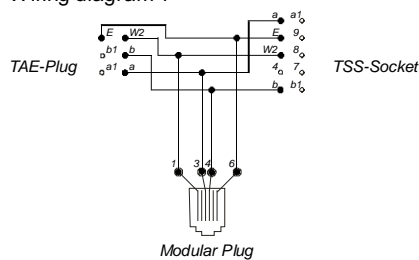

Wiring diagram 2

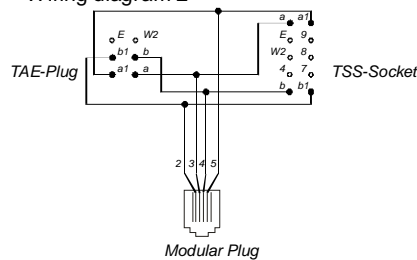

Wiring diagram 3

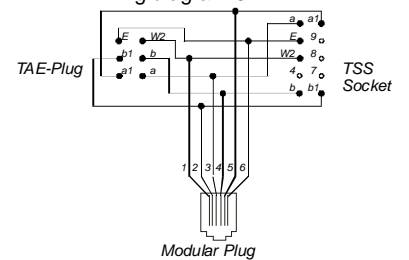



## EXTENSION CORDS

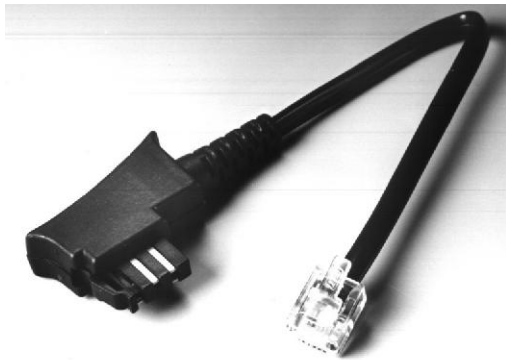

Plug - CODE			Lenght	Cable	Colour	Modular plug	Wiring diagram
F	N	U					
1 VA A03	1 VB A03	1 VC A03	3m	flat,2-cond.	black	6/2	1
1 VA A06	1 VB A06	1 VC A06	6m	flat,2-cond.	black	6/2	1
1 VA A10	1 VB A10	1 VC A10	10m	flat,2-cond.	black	6/2	1
	1 VB B03	1 VC B03	3m	flat,2-cond.	black	6/2	2
	1 VB B06	1 VC B06	6m	flat,2-cond.	black	6/2	2
	1 VB B10	1 VC B10	10m	flat,2-cond.	black	6/2	2
	1 VB G03	1 VC G03	3m	flat,4-cond.	black	6/4	3
	1 VB G06	1 VC G06	6m	flat,4-cond.	black	6/4	3
	1 VB G10	1 VC G10	10m	flat,4-cond.	black	6/4	3
1 VA U03		1 VC U03	3m	flat,4-cond.	black	6/4	4
1 VA U06		1 VC U06	6m	flat,4-cond.	black	6/4	4
1 VA U10		1 VC U10	10m	flat,4-cond.	black	6/4	4
1 VA I03		1 VC I03	3m	flat,4-cond.	black	6/4	5
1 VA I06		1 VC I06	6m	flat,4-cond.	black	6/4	5
1 VA I10		1 VC I10	10m	flat,4-cond.	black	6/4	5
	1 VB P03	1 VC P03	3m	flat,6-cond.	black	6/6	6
	1 VB P06	1 VC P06	6m	flat,6-cond.	black	6/6	6
	1 VB P10	1 VC P10	10m	flat,6-cond.	black	6/6	6
	1 VB R03	1 VC R03	3m	flat,6-cond.	black	6/6	7
	1 VB R06	1 VC R06	6m	flat,6-cond.	black	6/6	7
	1 VB R10	1 VC R10	10m	flat,6-cond.	black	6/6	7
1 GA A03	1 GB A03	1 GC A03	3m	spiral,2-cond.	black	6/2	1
1 GA A06	1 GB A06	1 GC A06	6m	spiral,2-cond.	black	6/2	1
	1 GB B03	1 GC B03	3m	spiral,2-cond.	black	6/2	2
	1 GB B06	1 GC B06	6m	spiral,2-cond.	black	6/2	2
	1 GB G03	1 GC G03	3m	spiral,4-cond.	black	6/4	3
	1 GB G06	1 GC G06	6m	spiral,4-cond.	black	6/4	3
1 GA U03		1 GC U03	3m	spiral,4-cond.	black	6/4	4
1 GA U06		1 GC U06	6m	spiral,4-cond.	black	6/4	4
1 GA I03		1 GC I03	3m	spiral,4-cond.	black	6/4	5
1 GA I06		1 GC I06	6m	spiral,4-cond.	black	6/4	5
	1 GB P03	1 GC P03	3m	spiral,6-cond.	black	6/6	6
	1 GB P06	1 GC P06	6m	spiral,6-cond.	black	6/6	6
	1 GB R03	1 GC R03	3m	spiral,6-cond.	black	6/6	7
	1 GB R06	1 GC R06	6m	spiral,6-cond.	black	6/6	7

Wiring diagram 1

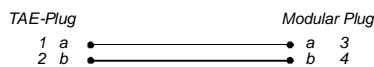

Wiring diagram 2

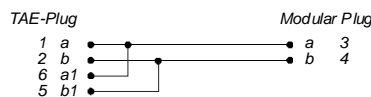

Wiring diagram 3

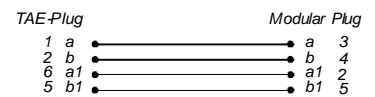

Wiring diagram 4

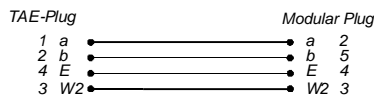

Wiring diagram 5

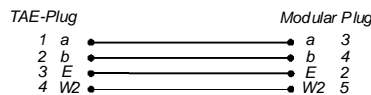

Wiring diagram 6

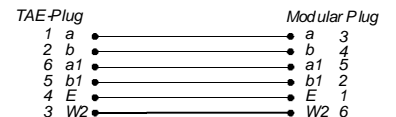

Wiring diagram 7

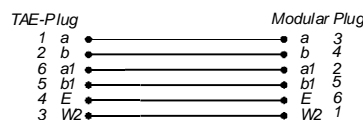

## EXTENSION CORDS

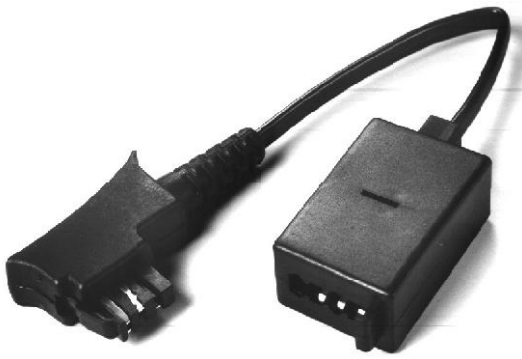

Plug - Code ( TAE-Socket U-type)			Length	Cable	Colour	Wiring diagram
F	N	U				
1 VS A03	1 VT A03	1 VU A03	3m	flat,2-cond.	black	1
1 VS A06	1 VT A06	1 VU A06	6m	flat,2-cond.	black	1
1 VS A10	1 VT A10	1 VU A10	10m	flat,2-cond.	black	1
	1 VT B03	1 VU B03	3m	flat,2-cond.	black	2
	1 VT B06	1 VU B06	6m	flat,2-cond.	black	2
	1 VT B10	1 VU B10	10m	flat,2-cond.	black	2
	1 VT G03	1 VU G03	3m	flat,4-cond.	black	3
	1 VT G06	1 VU G06	6m	flat,4-cond.	black	3
	1 VT G10	1 VU G10	10m	flat,4-cond.	black	3
	1 VT M03	1 VU M03	3m	flat,6-cond.	black	4
	1 VT M06	1 VU M06	6m	flat,6-cond.	black	4
	1 VT M10	1 VU M10	10m	flat,6-cond.	black	4
1 VS H03	1 VT H03	1 VU H03	3m	flat,4-cond.	black	5
1 VS H06	1 VT H06	1 VU H06	6m	flat,4-cond.	black	5
1 VS H10	1 VT H10	1 VU H10	10m	flat,4-cond.	black	5
1 GS A03	1 GT A03	1 GU A03	3m	spiral,2-cond.	black	1
1 GS A06	1 GT A06	1 GU A06	6m	spiral,2-cond.	black	1
1 GS A10	1 GT A10	1 GU A10	10m	spiral,2-cond.	black	1
	1 GT B03	1 GU B03	3m	spiral,2-cond.	black	2
	1 GT B06	1 GU B06	6m	spiral,2-cond.	black	2
	1 GT B10	1 GU B10	10m	spiral,2-cond.	black	2
	1 GT G03	1 GU G03	3m	spiral,4-cond.	black	3
	1 GT G06	1 GU G06	6m	spiral,4-cond.	black	3
	1 GT G10	1 GU G10	10m	spiral,4-cond.	black	3
	1 GT M03	1 GU M03	3m	spiral,6-cond.	black	4
	1 GT M06	1 GU M06	6m	spiral,6-cond.	black	4
	1 GT M10	1 GU M10	10m	spiral,6-cond.	black	4
1 GS H03	1 GT H03	1 GU H03	3m	spiral,4-cond.	black	5
1 GS H06	1 GT H06	1 GU H06	6m	spiral,4-cond.	black	5
1 GS H10	1 GT H10	1 GU H10	10m	spiral,4-cond.	black	5

Wiring diagram 1

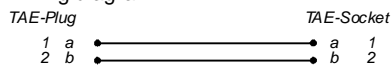

Wiring diagram 2

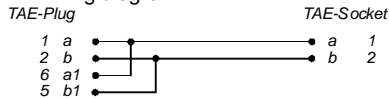

Wiring diagram 3

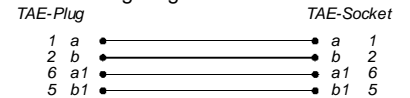

Wiring diagram 4

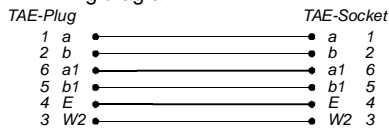

Wiring diagram 5

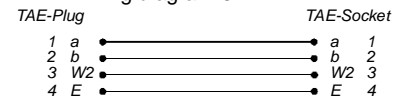

## EXTENSION CORDS

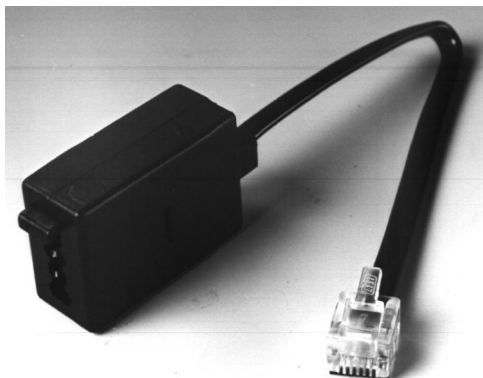

CODE	Length	Cable	Colour	Modular Plug	Wiring diagram
1 UJ A03	3m	flat,2-cond.	black	6/2	1
1 UJ A06	6m	flat,2-cond.	black	6/2	1
1 UJ A10	10m	flat,2-cond.	black	6/2	1
1 UJ A71	10cm	flat,2-cond.	black	6/2	1
1 UJ G03	3m	flat,4-cond.	black	6/4	2
1 UJ G06	6m	flat,4-cond.	black	6/4	2
1 UJ G10	10m	flat,4-cond.	black	6/4	2
1 UJ G71	10cm	flat,4-cond.	black	6/4	2
1 UJ H03	3m	flat,4-cond.	black	6/4	3
1 UJ H06	6m	flat,4-cond.	black	6/4	3
1 UJ H10	10m	flat,4-cond.	black	6/4	3
1 UJ H71	10cm	flat,4-cond.	black	6/4	3

TAE - Socket U - type

Wiring diagram 1

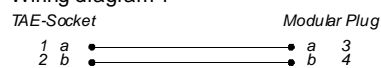

Wiring diagram 2

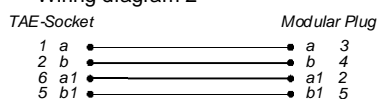

Wiring diagram 3

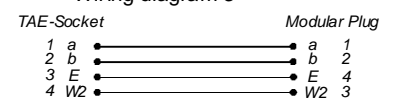

## EXTENSION CORDS

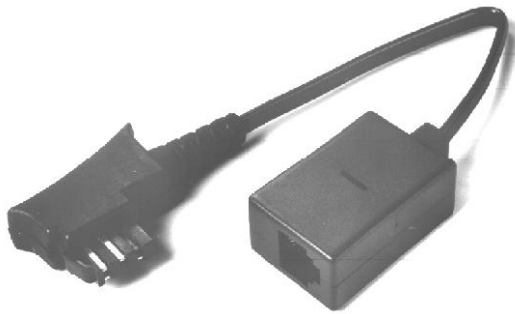

Plug - kodierung ( TAE-socket U-kodiert )			Length	Cable	Colour	Modular socket	Wiring diagram
F	N	U					
1 VPA03	1 VQA03	1 VRA03	3m	flat,2-cond.	black	6/2	1
1 VPA06	1 VQA06	1 VRA06	6m	flat,2-cond.	black	6/2	1
1 VPA10	1 VQA10	1 VRA10	10m	flat,2-cond.	black	6/2	1
	1 VQB03	1 VRB03	3m	flat,2-cond.	black	6/2	2
	1 VQB06	1 VRB06	6m	flat,2-cond.	black	6/2	2
	1 VQB10	1 VRB10	10m	flat,2-cond.	black	6/2	2
	1 VQG03	1 VRG03	3m	flat,4-cond.	black	6/4	3
	1 VQG06	1 VRG06	6m	flat,4-cond.	black	6/4	3
	1 VQG10	1 VRG10	10m	flat,4-cond.	black	6/4	3
1 VP U03		1 VR U03	3m	flat,4-cond.	black	6/4	4
1 VP U06		1 VR U06	6m	flat,4-cond.	black	6/4	4
1 VP U10		1 VR U10	10m	flat,4-cond.	black	6/4	4
1 VP I03		1 VR I03	3m	flat,4-cond.	black	6/4	5
1 VP I06		1 VR I06	6m	flat,4-cond.	black	6/4	5
1 VP I10		1 VR I10	10m	flat,4-cond.	black	6/4	5
	1 VQP03	1 VRP03	3m	flat,6-cond.	black	6/6	6
	1 VQP06	1 VRP06	6m	flat,6-cond.	black	6/6	6
	1 VQP10	1 VRP10	10m	flat,6-cond.	black	6/6	6

Wiring diagram 1

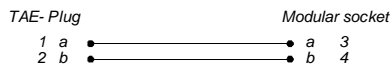

Wiring diagram 2

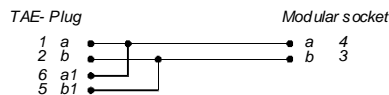

Wiring diagram 3

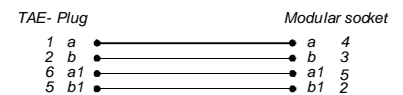

Wiring diagram 4

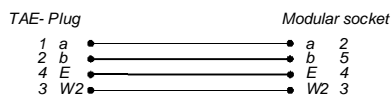

Wiring diagram 5

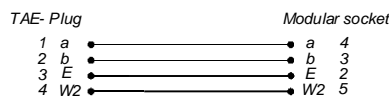

Wiring diagram 6

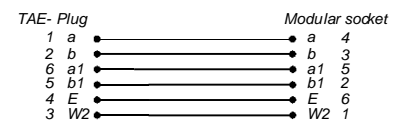

## MODULAR COUPLER TAE / MODULAR SOCKET

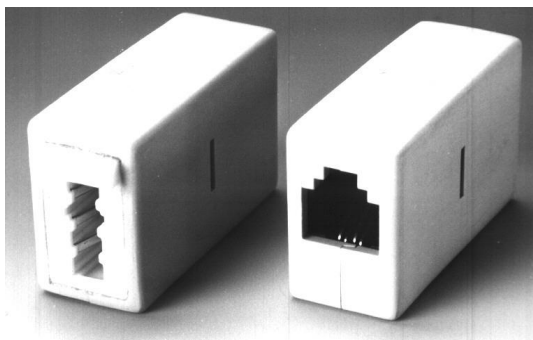

CODE	Cable	Colour	Modular Sockete	Wiring diagram
1 AK 001	2 - C	Black	6/2	1
1 AK 002	4 - C	Black	6/4	2
1 AK 003	4 - C	Black	6/4	3
1 AK 004	6 - C	Black	6/6	4

TAE - Socket - Cable: U (universal)

Wiring diagram 1

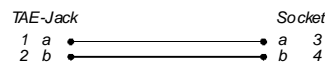

Wiring diagram 2

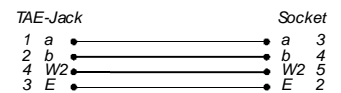

ABMESSUNGEN

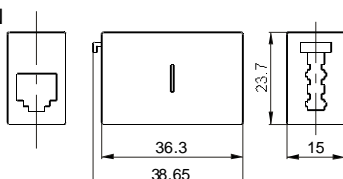

Wiring diagram 1

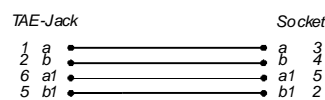

Wiring diagram 2

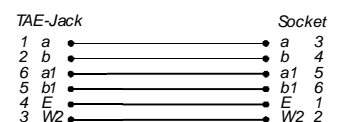

## EXTENSION CORDS

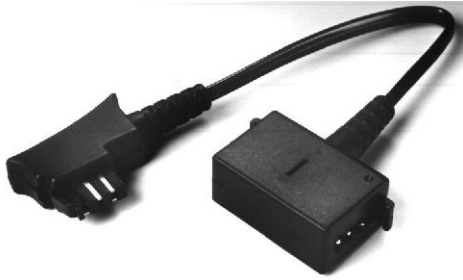

Jack - type ( TAE-Jack U-type )			Lenght	Typ	Colour	Wiring diagram
F	N	U				
1 VW Y71	1 VV Y71	1 VZ Y71	10cm	flat, 2 C	black	1
1 VW Z71	1 VV Z71	1 VZ Z71	10cm	flat, 2 C	black	2
	1 VV U71	1 VZ U71	10cm	flat, 2 C	black	3
1 VW V71		1 VZ V71	10cm	flat, 2 C	black	4
	1 VV X71	1 VZ X71	10cm	flat, 2 C	black	5

Wiring diagram 1

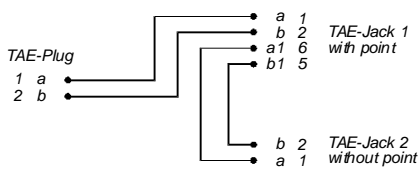

Wiring diagram 2

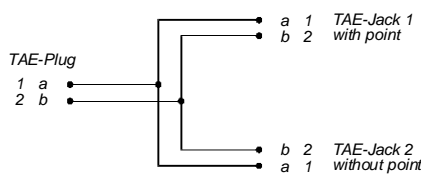

Wiring diagram 3

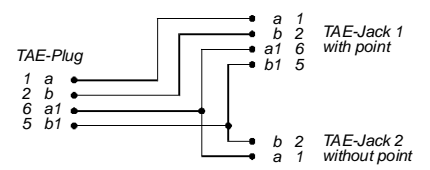

Wiring diagram 4

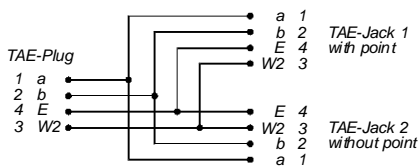

Wiring diagram 5

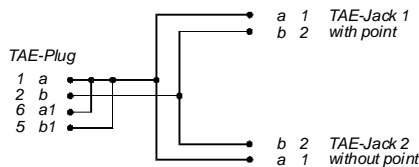

## EXTENSION CORDS

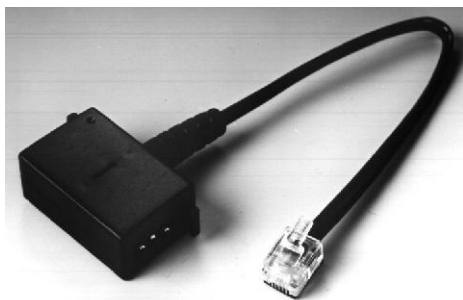

CODE	Lenght	Cable	Colour	Modular Jack	Wiring diagram
1 UU A71	10cm	flat, 2 C	black	6/2	1
1 UU B71	10cm	flat, 2 C	black	6/2	2
1 UU H71	10cm	flat, 4 C	black	6/4	3
1 UU M71	10cm	flat, 4 C	black	6/4	4
TAE - Jack U - type					
On request F or N - type					

Wiring diagram 1

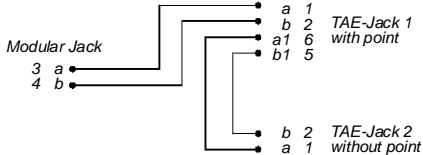

Wiring diagram 2

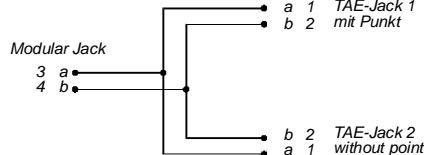

Wiring diagram 3

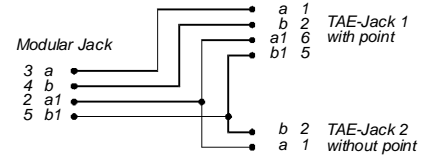

Wiring diagram 4

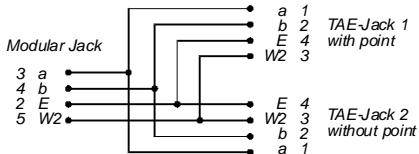

## EURO JACK



CODE	Type	Modular Socket	Colour	Mounting
1DNA 300	N - F - N	0	White	Flash
1DNA 301	N - F - N	1 x 6/6	White	Flash
1DNA 302	N - F - N	2 x 6/6	White	Flash
1DNA 303	N - F - N	3 x 6/6	White	Flash
1DNA 001	-	1 x 6/6	White	Flash
1DNA 002	-	2 x 6/6	White	Flash
1DNA 003	-	3 x 6/6	White	Flash
1DNA 101	F	1 x 6/6	White	Flash
1DNA 102	F	2 x 6/6	White	Flash
1DNA 103	F	3 x 6/6	White	Flash
1DNA 310	N - F - N	0	White	Surface
1DNA 311	N - F - N	1 x 6/6	White	Surface
1DNA 312	N - F - N	2 x 6/6	White	Surface
1DNA 313	N - F - N	3 x 6/6	White	Surface
1DNA 011	-	1 x 6/6	White	Surface
1DNA 012	-	2 x 6/6	White	Surface
1DNA 013	-	3 x 6/6	White	Surface
1DNA 111	F	1 x 6/6	White	Surface
1DNA 112	F	2 x 6/6	White	Surface
1DNA 113	F	3 x 6/6	White	Surface
1DNA V310	N - F - N	0	White	Socket
1DNA V313	N - F - N	3 x 6/6	White	Socket
1DNA V013	-	3 x 6/6	White	Socket

### ASSEMBLING DATA

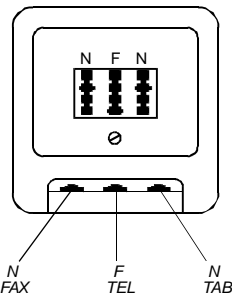
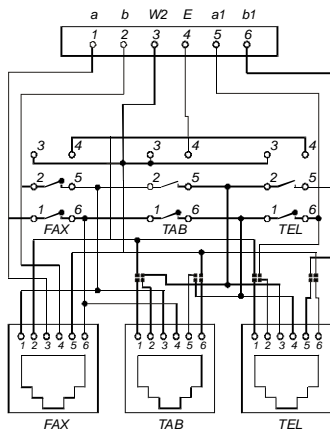
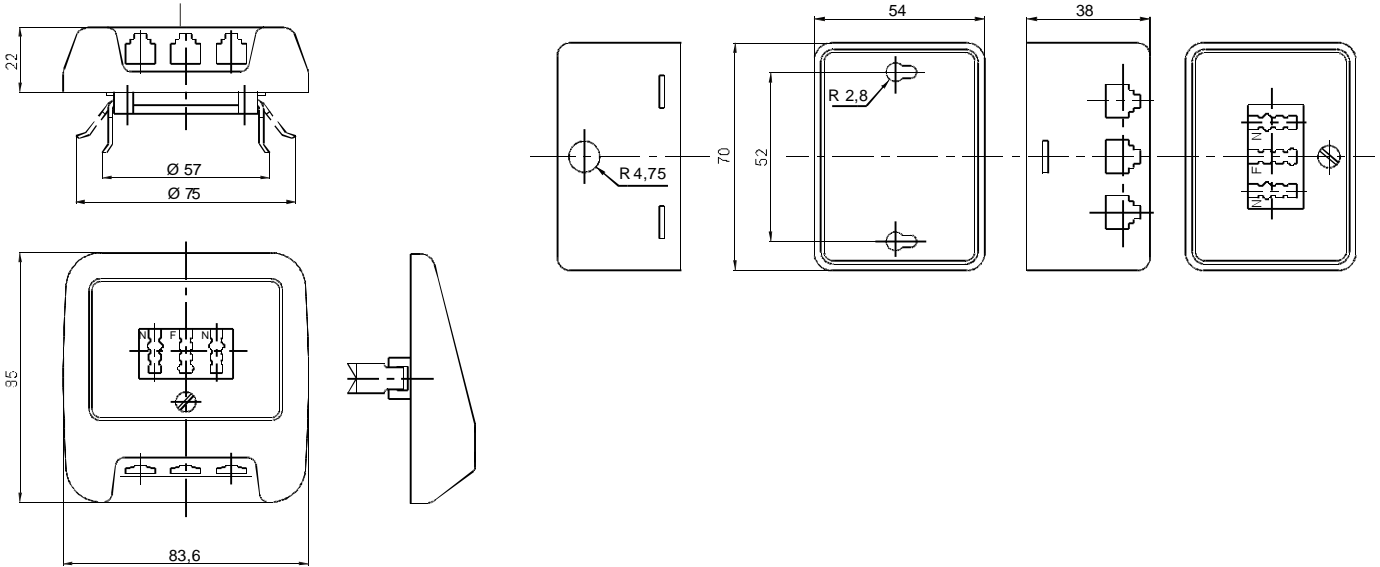

FAX: Fax or Modem  
 TEL: Telephone  
 TAB: Answer machine

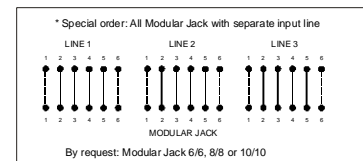

## ADAPTER TAE-TSS

CODE	Socket	Plug	Wiring diagram
1 AN 031	3 x TAE	TAE	1
1 AN 035	3 x TAE	TSS	2
1 AS 035	3 x TSS	TAE	3

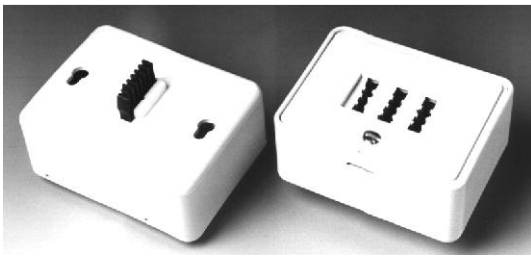
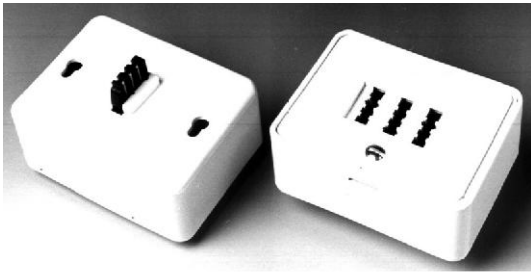

### ASSEMBLING DATA

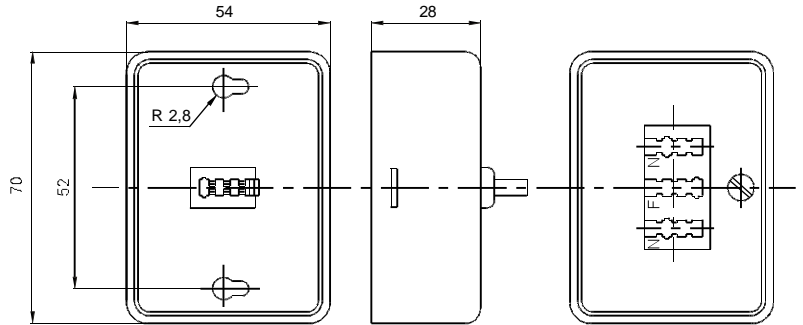

Wiring diagram 1

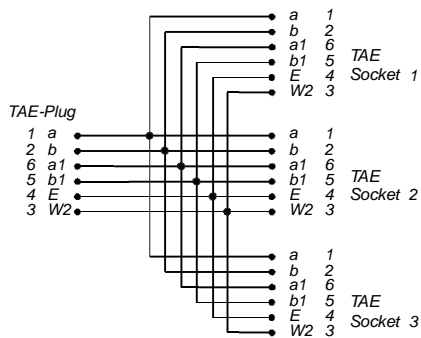

Wiring diagram 2

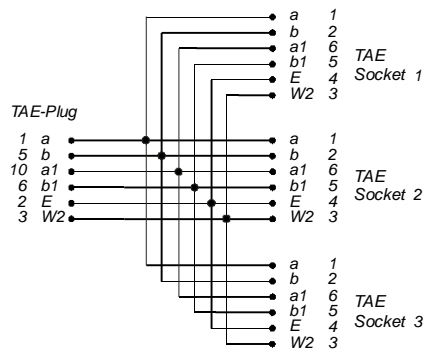

Wiring diagram 3

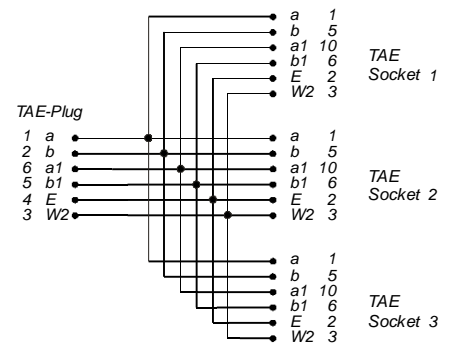

## TAE - LINETESTER

CODE

1 EA 055

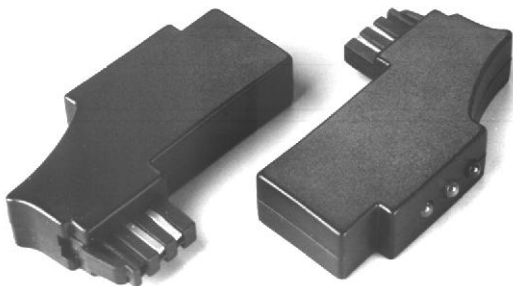

LED	FUNCTION
NOTING	NO Signal
RED	Current < 20 mA
GREEN	O.K. Line AB
YELLOW	O.K. Line BA
RED+ GREEN	AB > 60 mA
RED+ YELLOW	BA > 60 mA

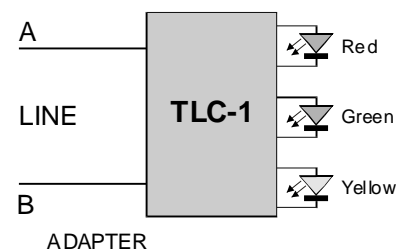

## EURO JACK

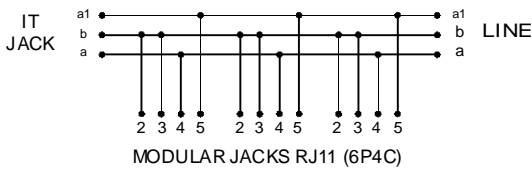

CODE			MODULAR JACK		
Flash mounting	Surface mounting	IT. jack	RJ 11	RJ 11	RJ 11
1 DIA 100	1 DIA 110	3 cont.	—	—	—
1 DIA 101	1 DIA 111	3 cont.	—	6/4	—
1 DIA 102	1 DIA 112	3 cont.	6/4	—	6/4
1 DIA 103	1 DIA 113	3 cont.	6/4	6/4	6/4

\* Special order ( other colours possible )

### ASSEMBLING DATA

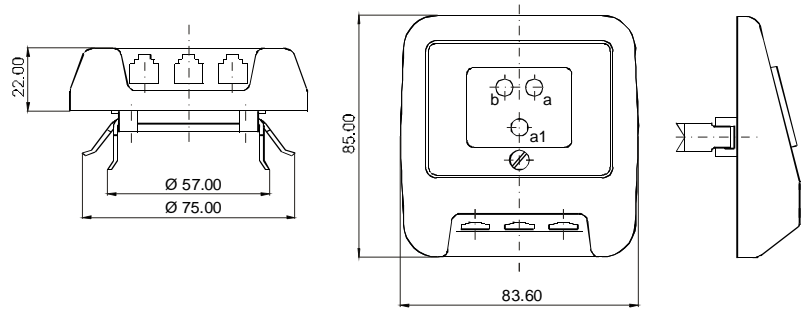

## PLUGS AND ADAPTERS



CODE						
Black	White	It. jack	It. plug	modular jack	modular jack	wiring diagram
1 A/N 009	1 A/N 109	—	3 cont.	6/2	—	1
1 A/N 003	1 A/N 103	3 cont.	3 cont.	6/2	—	2
1 AI 021P	1 AI 121P	3 cont.	3 cont.	6/4	—	3
1 AI 034A	1 AI 134A	—	3 cont.	6/4	8/4	ADSL

1 EI 001 | 1 EI 101 | Automatic telephone switcher  
See wiring diagram 1EA 002 on page 36

### ASSEMBLING DATA

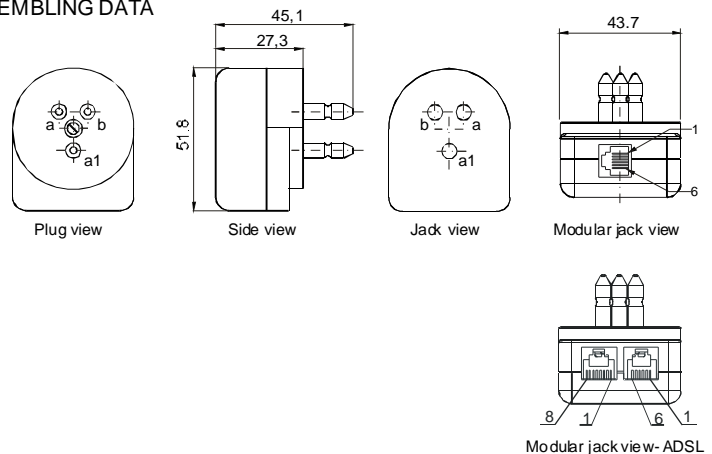

### WIRING DIAGRAM 1

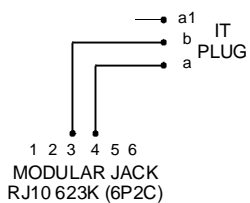

### WIRING DIAGRAM 2

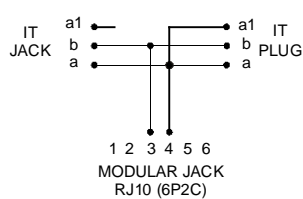

### WIRING DIAGRAM 3

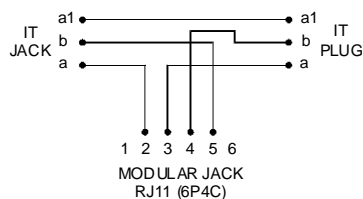

### WIRING DIAGRAM ADSL

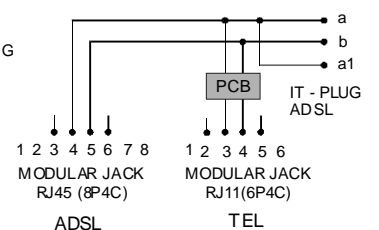

## ITALIAN PLUG

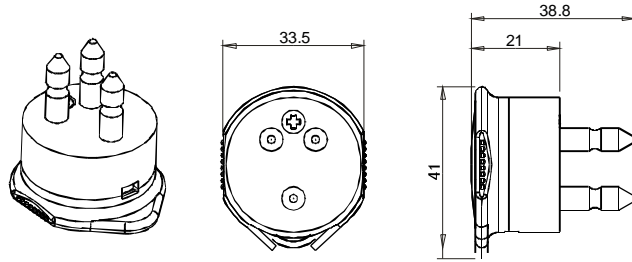

CODE	Colour
1 CIN 001	Black
1 CIN 101	White
1 CIN 201	Ivory

Plug is delivered in unassembled state.

## ADAPTERS

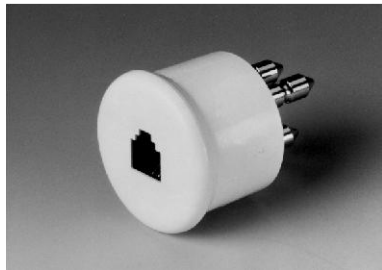
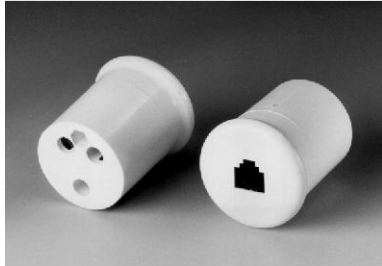

CODE			IT. jack	IT. plug	Mod. jack	Assembling data
Black	White	Ivory				
1 CI 010	1 CI 110	1 CI 210	3 cont.	no	RJ11	1
1 CI 011	1 CI 111	1 CI 211	no	3 cont.	RJ11	2

### ASSEMBLING DATA 1

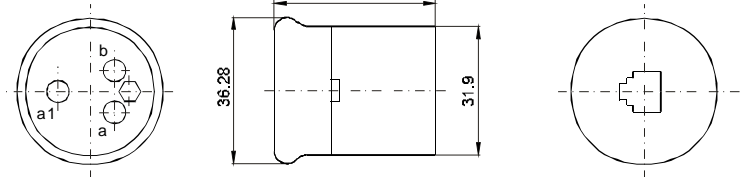

### ASSEMBLING DATA 2

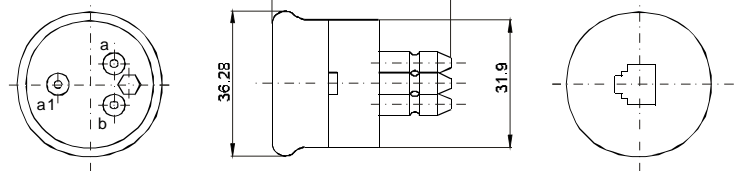

### WIRING DIAGRAM 1

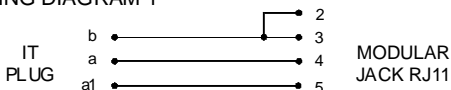

### WIRING DIAGRAM 2

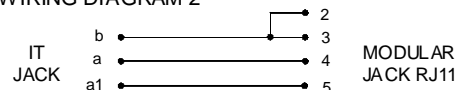

## EXTENSION CORDS

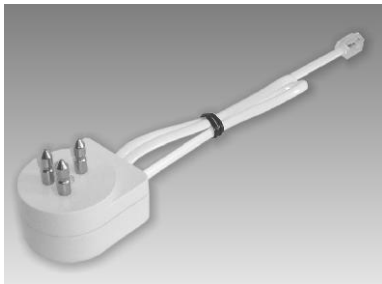

Options:  
standard cable colour: Black, White  
Cable length : 0,2 to ... meters  
Typ of cable: flat or round

BY REQUEST

### WIRING DIAGRAM

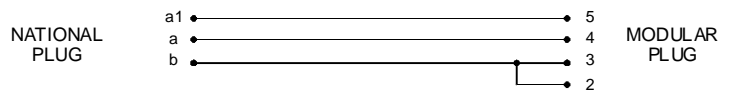

## EXTENSION SOCKET



### WIRING DIAGRAM

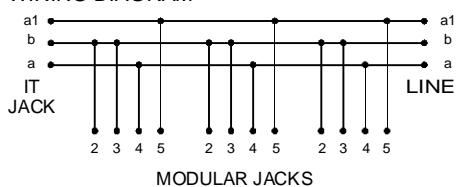

			MODULAR JACKS		
WHITE	IVORY	IT. JACK	RJ 11	RJ 11	RJ 11
1DIAV110	1DIBV110	3 cont.	-	-	-
1DIAV111	1DIBV111	3 cont.	-	6/4	-
1DIAV112	1DIBV112	3 cont.	6/4	-	6/4
1DIAV113	1DIBV113	3 cont.	6/4	6/4	6/4

\* Special order ( other colours possible )

### ASSEMBLING DATA

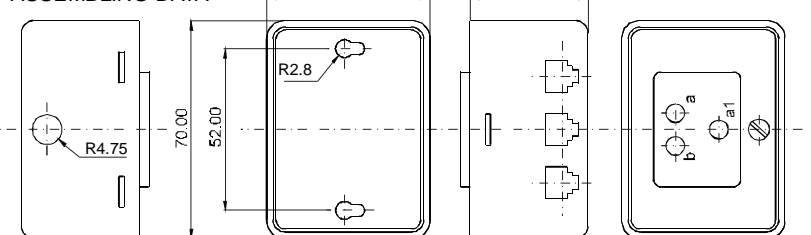



## EURO JACK



CODE		CZ. jack	MODULAR JACK		
Flash mounting	Surface mounting		RJ 11	RJ 11	RJ 11
1 DGA 100	1 DGA 110	4 cont.	—	—	—
1 DGA 101	1 DGA 111	4 cont.	—	6/4	—
1 DGA 102	1 DGA 112	4 cont.	6/4	—	6/4
1 DGA 103	1 DGA 113	4 cont.	6/4	6/4	6/4

\* Special order ( other colours possible )

### ASSEMBLING DATA

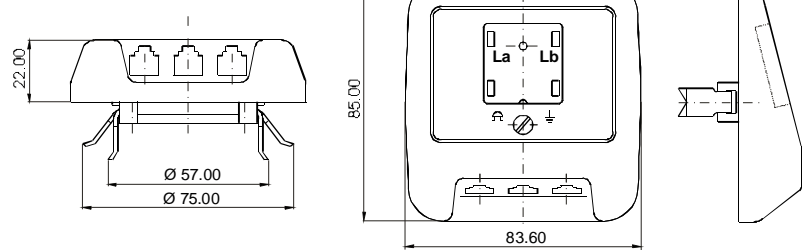

### WIRING DIAGRAM

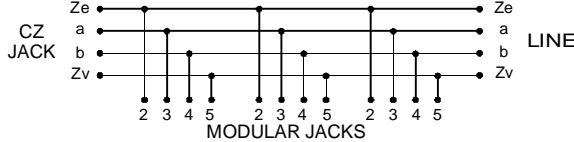

## EXTENSION CORD

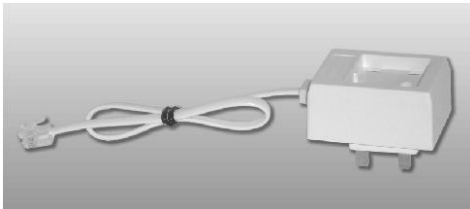

### OPTIONS:

- Standard cable colour: Black, White
- Cable length: 0,2 to ... meters
- Typ of cable : flat or round

BY REQUEST

### WIRING DIAGRAM

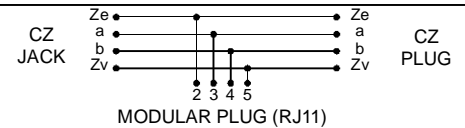

## COMBINED PLUGS AND ADAPTERS

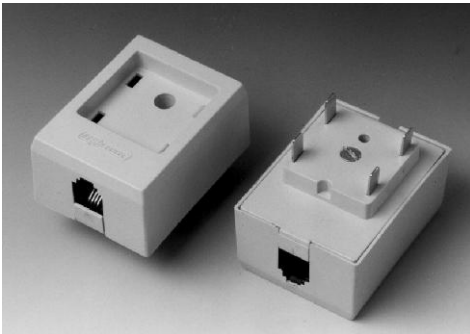

CODE		CZ jack	CZ plug	Mod.jack RJ 11	Protect sleeve	Wiring diagram
Black	White					
1 AG 001	1 AG 101	4 cont.	4 cont.	6/4	—	1
1 AG 013	1 AG 113	—	4 cont.	6/4	—	1

\* Special order ( other colours possible )

### ASSEMBLING DATA

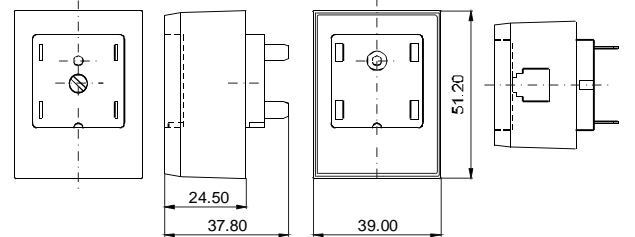

### WIRING DIAGRAM

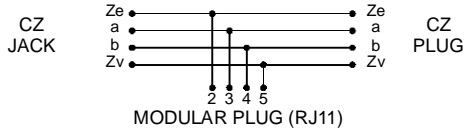

## EXTENSION SOCKET



CODE	CZ. jack	MODULAR JACK		
		RJ 11	RJ 11	RJ 11
1 DGAV 110	4 cont.	—	—	—
1 DGAV 111	4 cont.	—	6/4	—
1 DGAV 112	4 cont.	6/4	—	6/4
1 DGAV 113	4 cont.	6/4	6/4	6/4

\* Special order ( other colours possible )

### ASSEMBLING DATA

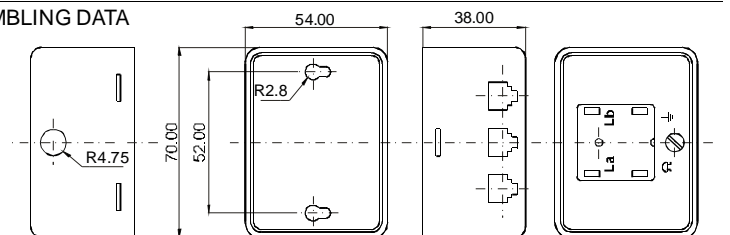

### WIRING DIAGRAM

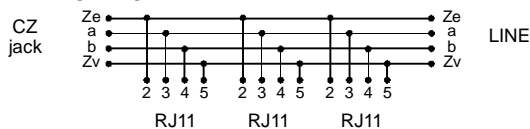

## EURO JACK

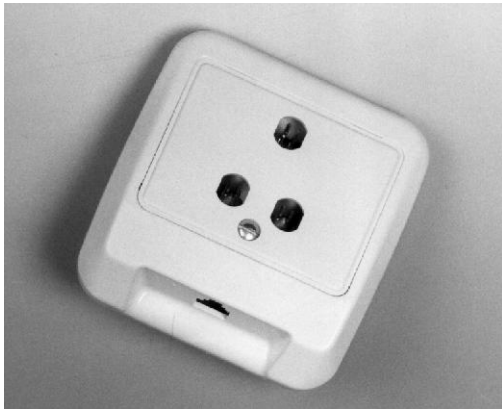

CODE		HU. jack	MODULAR JACK		
Flash mount.	Surface mount.				
1 DMA100	1 DMA110	3 cont.	-	-	-
1 DMA101	1 DMA111	3 cont.	-	6/3	-
1 DMA102	1 DMA112	3 cont.	6/3	-	6/3
1 DMA103	1 DMA113	3 cont.	6/3	6/3	6/3

\* Special order ( other colours possible )

### ASSEMBLING DATA

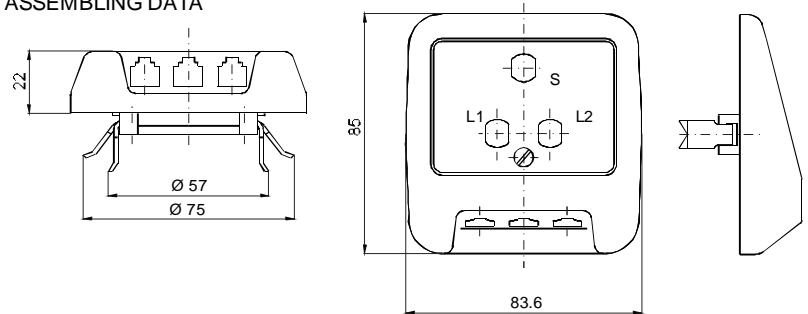

### WIRING DIAGRAM

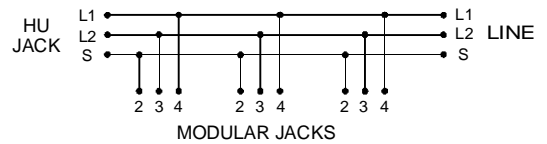

## PLUGS AND ADAPTERS



CODE					
Black	White	Hu. jack	Hu. plug	Mod. jack	Protect sleeve
1 AM001	1 AM101	3 cont.	3 cont.	6/3	-
1 AM011	1 AM111	-	3 cont.	6/3	-

\* Special order ( other colours possible )

### ASSEMBLING DATA

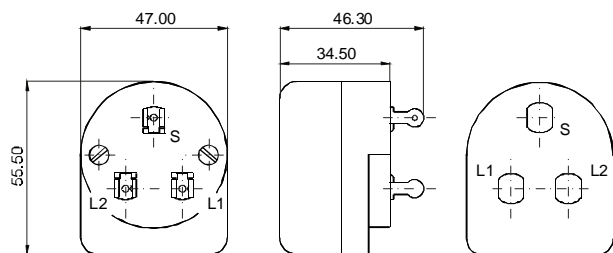

### WIRING DIAGRAM

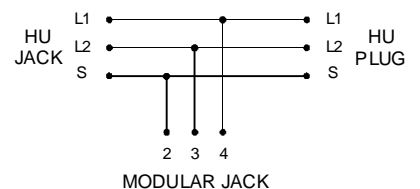

## EURO JACK



CODE			MODULAR JACK		
Flash mount.	Surface mount.	Ru. jack	RJ 11	RJ 11	RJ 11
1 DPA100	1 DPA110	4 cont.	—	—	—
1 DPA101	1 DPA111	4 cont.	—	6/4	—
1 DPA102	1 DPA112	4 cont.	6/4	—	6/4
1 DPA103	1 DPA113	4 cont.	6/4	6/4	6/4

\* Special order ( other colours possible )

### ASSEMBLING DATA

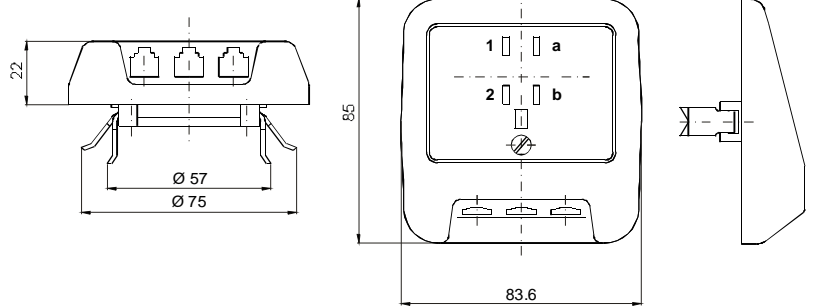

### WIRING DIAGRAM

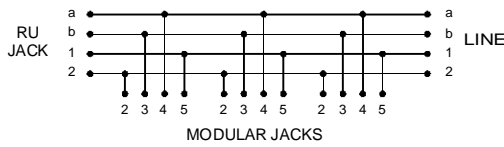

## ADAPTERS

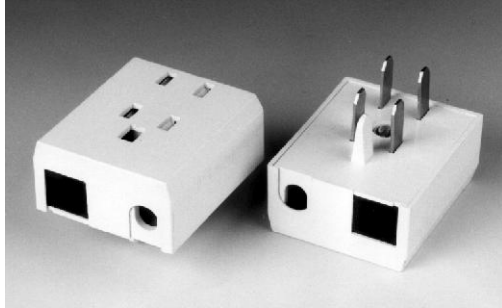

CODE					
Black	White	Ru. jack	Ru. plug	Modjack RJ 11	Protect sleeve
1 AR001	1 AR 101	4 cont.	4 cont.	6/4	—
1 AR011	1 AR 111	—	4 cont.	6/4	—

\* Special order ( other colours possible )

### WIRING DIAGRAM

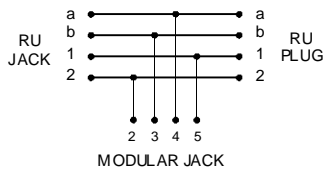

### ASSEMBLING DATA

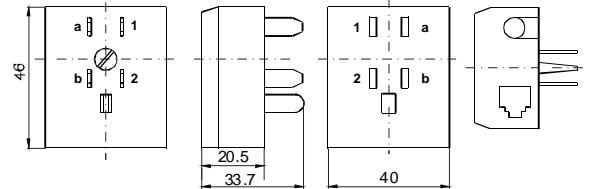

## EXTENSION SOCKET



CODE	Ru. jack	MODULAR JACK		
		RJ 11	RJ 11	RJ 11
1DPAV110	4 cont.	—	—	—
1DPAV111	4 cont.	—	6/4	—
1DPAV112	4 cont.	6/4	—	6/4
1DPAV113	4 cont.	6/4	6/4	6/4

\* Special order ( other colours possible )

### ASSEMBLING DATA

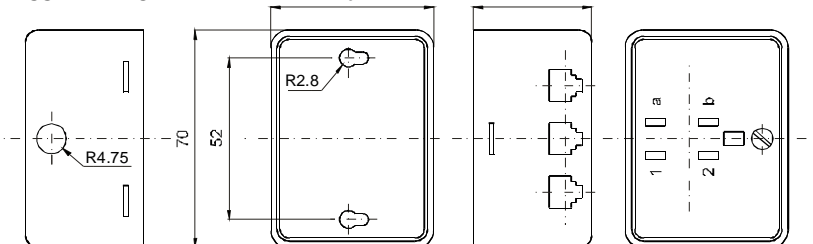

### WIRING DIAGRAM

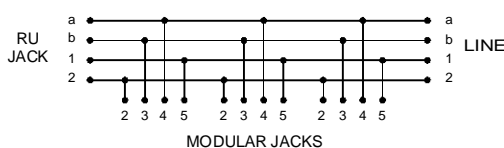

# SWISS TYPE



## SWISS EURO JACK

( T+T 83 jack -3 X FCC 6/4 jack )



WHITE		CH. JACK	MODULAR JACK		
flash mounting	surface mounting.		RJ 11	RJ 11	RJ 11
1 DJA 100	1 DJA 110	1x (4C)	-	-	-
1 DJA 101	1 DJA 111	1x (4C)	-	6/4	-
1 DJA 102	1 DJA 112	1x (4C)	6/4	-	6/4
1 DJA 103	1 DJA 113	1x (4C)	6/4	6/4	6/4
-	1 DJA 200	2x (4C)	6/4	6/4	6/4
-	1 DJA 203M	2x (4C)	TEL	MOD	TEL
-	1 DJA 210	2x (4C)	6/4	6/4	6/4
-	1 DJA 213M	2x (4C)	TEL	MOD	TEL

\* Special order ( other colours possible )

### ASSEMBLING DATA

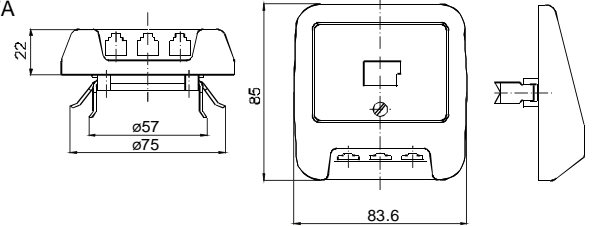

### WIRING DIAGRAM

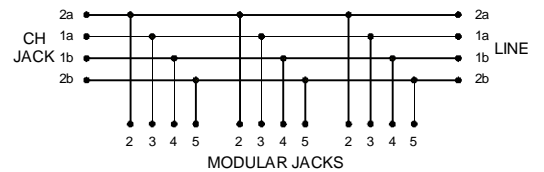
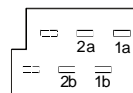
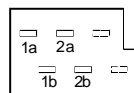

## EXTENSION SOCKET

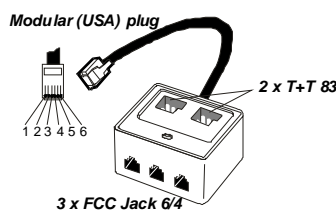
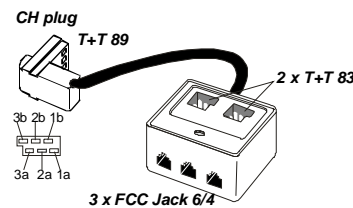

Code for modular jack			Plug	Length
1 X 6/4	2 X 6/4	3 X 6/4		
1 BJH 4031	1 BJH 4032	1 BJH 4033	CH	3m
1 BJH 4051	1 BJH 4052	1 BJH 4053	CH	5m
1 BJH 4101	1 BJH 4102	1 BJH 4103	CH	10m
1 BJH 4151	1 BJH 4152	1 BJH 4153	CH	15m
1 BJS 4031	1 BJS 4032	1 BJS 4033	USA	3m
1 BJS 4051	1 BJS 4052	1 BJS 4053	USA	5m
1 BJS 4101	1 BJS 4102	1 BJS 4103	USA	10m
1 BJS 4151	1 BJS 4152	1 BJS 4153	USA	15m
1 BJM 4031	1 BJM 4032	1 BJM 4033	CH	3m
1 BJM 4051	1 BJM 4052	1 BJM 4053	CH	5m
1 BJM 4101	1 BJM 4102	1 BJM 4103	CH	10m
1 BJM 4151	1 BJM 4152	1 BJM 4153	CH	15m
1 BJN 4031	1 BJN 4032	1 BJN 4033	USA	3m
1 BJN 4051	1 BJN 4052	1 BJN 4053	USA	5m
1 BJN 4101	1 BJN 4102	1 BJN 4103	USA	10m
1 BJN 4151	1 BJN 4152	1 BJN 4153	USA	15m

## CH TELEPHONE ADAPTER

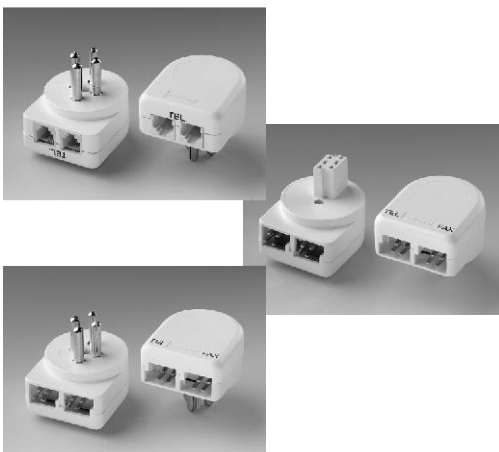

Code	Description
1 AK 137	Adapter CH T+T89 Plug / 2x T+T83 Jack
1 AK 137 F	Adapter CH T+T89 / 1x T+T83 Jack, 1x T+T83 Jack/Fax
1 AK 136	Adapter CH Old plug / 2x T+T83 Jack
1 AK 136 F	Adapter CH Old plug / 1x T+T83 Jack, 1x T+T Jack/Fax
1 AK 134	Adapter CH Old plug / 2x RJ11 (6P4C)

### Wiring diagram 1AK137

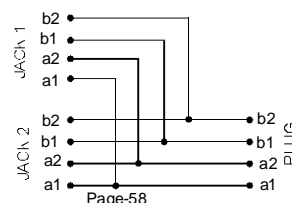

### Wiring diagram 1AK137F

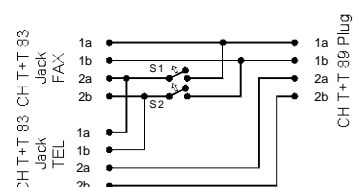

## SWISS PLUG

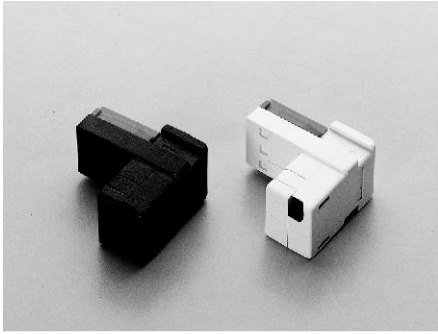

Code	
White	Black
1 CJ 101	1 CJ 001

### ASSEMBLING DATA

Plug is delivered in unassembled state.

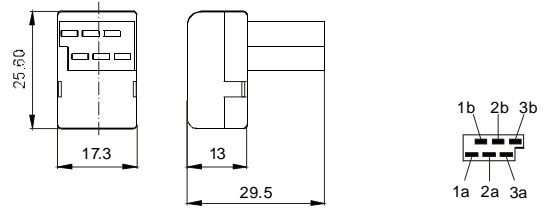

## ADAPTER (T+T 89 plug - FCC 6/4 jack)

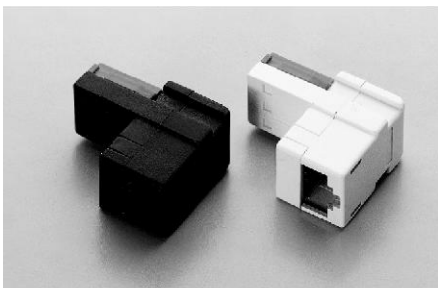

Code CH		Code USA	
White	Black	White	Black
1 AK 132	1 AK 032	1 AK 132U	1 AK 032U

ISDN			
1 AK 133	1 AK 033	1 AK 133U	1 AK 033U

### ASSEMBLING DATA

T+T 89

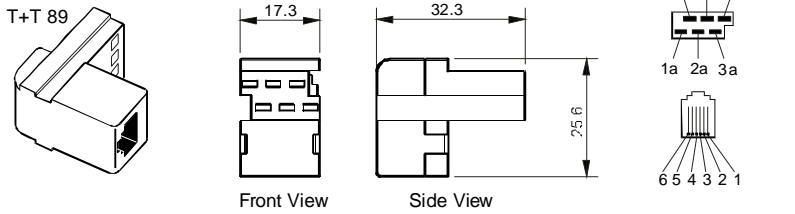

## ADAPTER (FCC 6/4,6/6 jack - T+T 83 jack)

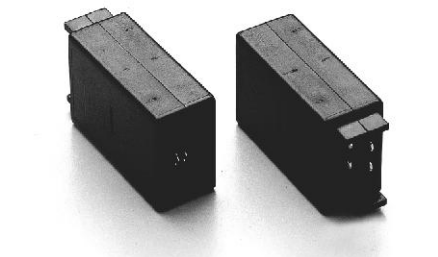

Code		
White	Black	FCC JACK
1 AK 131	1 AK 031	6/4
1 AK 130	1 AK 030	6/6

### ASSEMBLING DATA

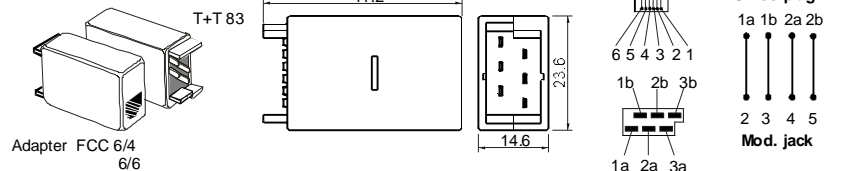

## TELEPHONE ADAPTER

(T+T 89 plug - T+T 83 jack - FCC 6/4 jack)



Code CH		Code USA	
White	Black	White	Black
1 AJ 104	1 AJ 004	1 AJ 104U	1 AJ 004U

### ASSEMBLING DATA

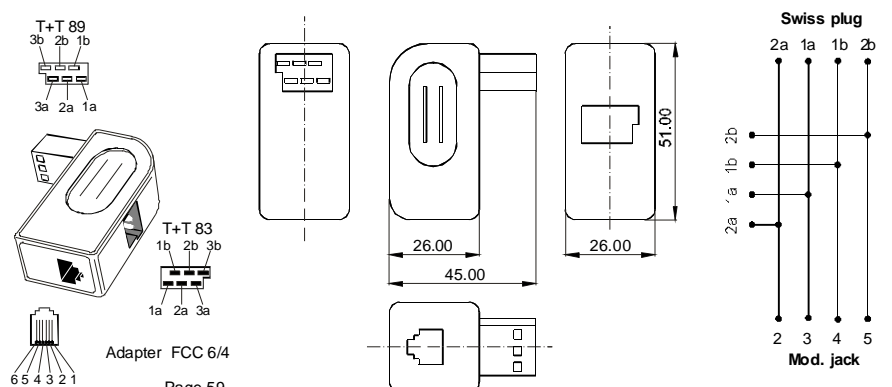

## SWISS EXTENSION CORD (PLUG / CORD / MAGIC BOX)

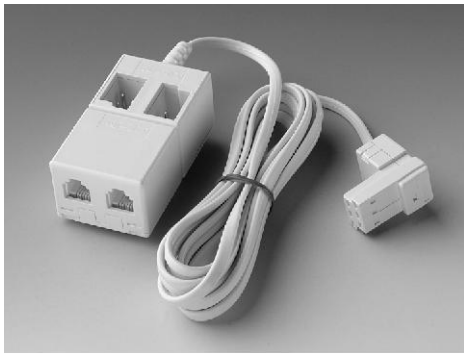

Different types of extension cords are possible (different plugs, cables, magic boxes, wirings,...)



## SWISS EXTENSION CORD (T+T 89 plug - FCC 6/4 plug)

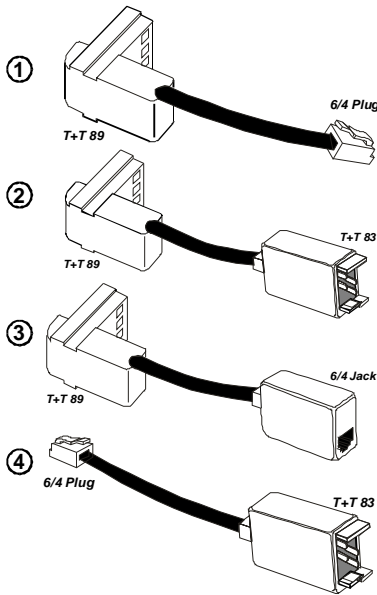
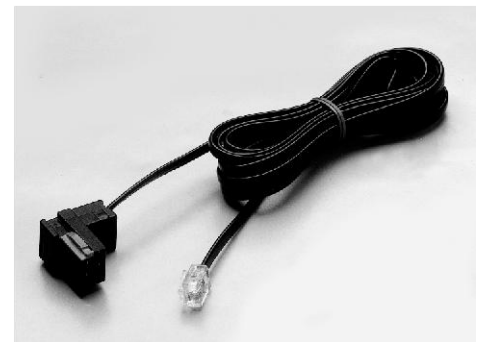
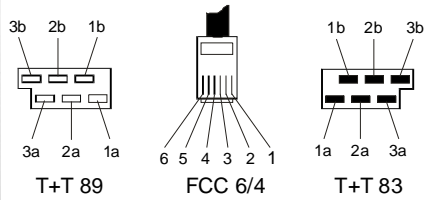
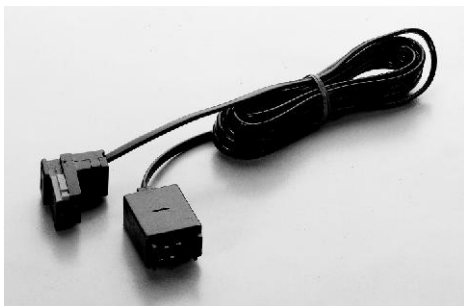

	1. END	2. END	Standard Cable length	CODE	
				White	Black
①	T+T 89	Plug 6/4	3 m	1BJA403B	1BJA403
②	T+T 89	T+T 83	3 m	1BJV403B	1BJV403
③	T+T 89	Jack 6/4	3 m	1BJC403B	1BJC403
④	Plug 6/4	T+T 83	3 m	1BJB403B	1BJB403

### OPTIONS:

- Standard cable colour: Black, White
- Cable length: 0,2 to ... meters
- Typ of cable: flat or round

BY REQUEST

### WIRING DIAGRAM

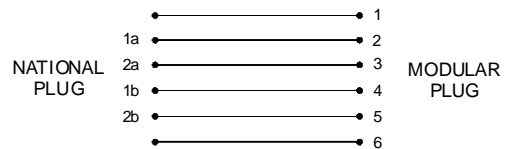

\* Other wiring possible!

## TELEPHONE LINE CHECKER

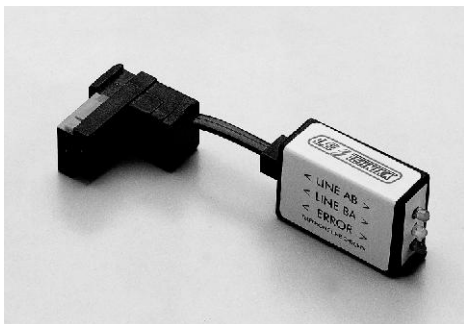

LIGHT	FUNCTION
No	no line connection
Red	current < 20 mA
Green	O.K. line AB
Yellow	O.K. line BA
Red & Green	AB current > 60 mA
Red & Yellow	BA current > 60 mA

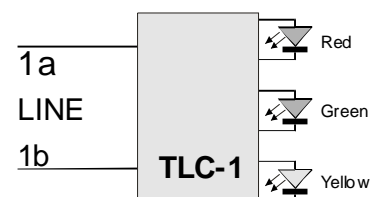

CODE

1 EA 054

## EURO JACK



CODE			MODULAR JACK		
Flash mounting	Surface mounting	Bel. jack	RJ 11	RJ 11	RJ 11
1 DLA100	1 DLA110	4 cont.	—	—	—
1 DLA101	1 DLA111	4 cont.	—	6/4	—
1 DLA102	1 DLA112	4 cont.	6/4	—	6/4
1 DLA103	1 DLA113	4 cont.	6/4	6/4	6/4

\* Special order ( other colours possible )

### ASSEMBLING DATA

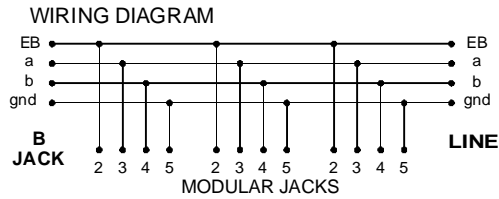
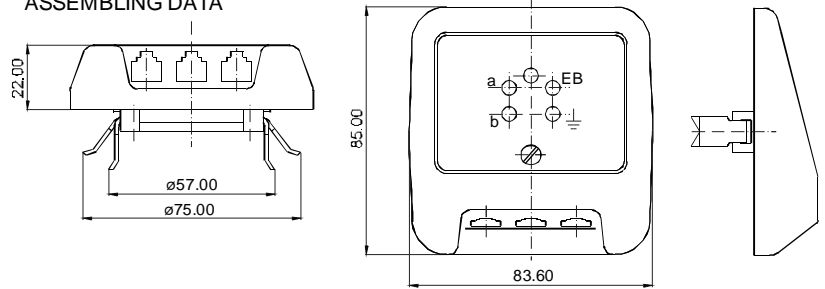

## EXTENSION SOCKET



CODE	Bel. jack	MODULAR JACK		
		RJ 11	RJ 11	RJ 11
1DLAV110	4 cont.	—	—	—
1DLAV111	4 cont.	—	6/4	—
1DLAV112	4 cont.	6/4	—	6/4
1DLAV113	4 cont.	6/4	6/4	6/4

\* Special order ( other colours possible )

### ASSEMBLING DATA

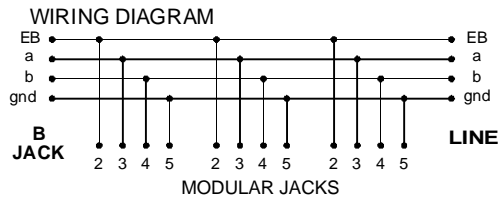
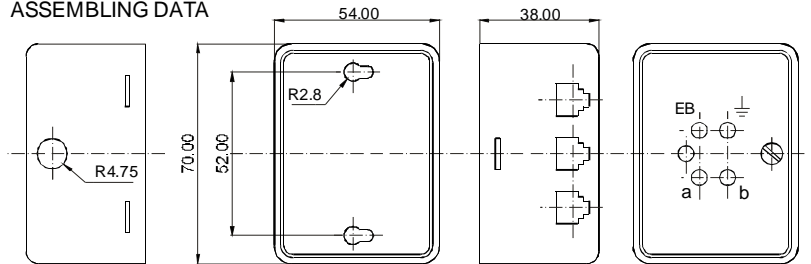

## BELGIAN ADAPTERS



### WIRING DIAGRAM - ADAPTER

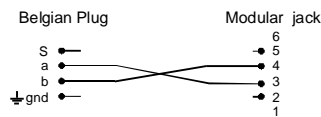

### WIRING DIAGRAM - COMBINED ADAPTER

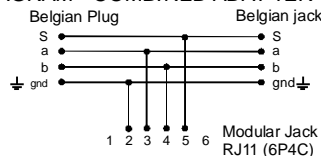

CODE	Bel. plug	Bel. jack	RJ 11	Spec.
1A BL 101	Yes	Yes	1 x	
1A BL 110	No	Yes	1 x	
1A BL 111	Yes	No	1 x	
1A BL 132	Yes	No	2 x	
1ABL101A	Yes	No	2 x	ADSL

\* Special order ( other colours possible )

See dimensions on page 50

## BELGIAN EXTENSION CORD



### OPTIONS:

- Standard cable colour: Black, White
- Cable length: 0,2 to ... meters
- Typ of cable : flat or round

**BY REQUEST**

### WIRING DIAGRAM

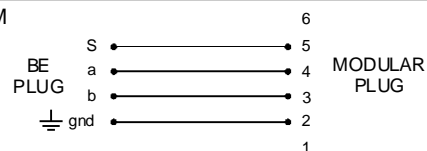

# HOLLAND (DUTCH) TYPE



## EURO JACK



CODE		MODULAR JACK			
Flash mounting	Surface mounting	Dutch jack	RJ 11	RJ 11	RJ 11
1 DHA100	1 DHA110	4 cont.	—	—	—
1 DHA101	1 DHA111	4 cont.	—	6/4	—
1 DHA102	1 DHA112	4 cont.	6/4	—	6/4
1 DHA103	1 DHA113	4 cont.	6/4	6/4	6/4

\* Special order ( other colours possible )

### ASSEMBLING DATA

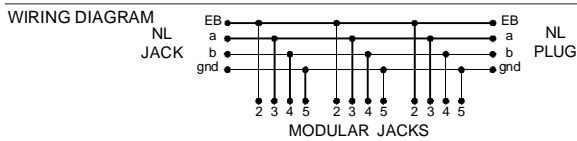
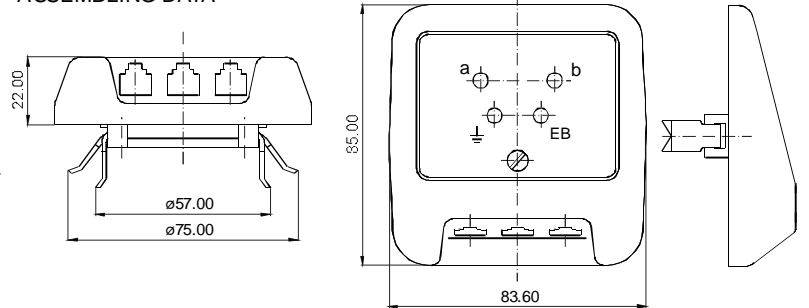

## ADAPTERS

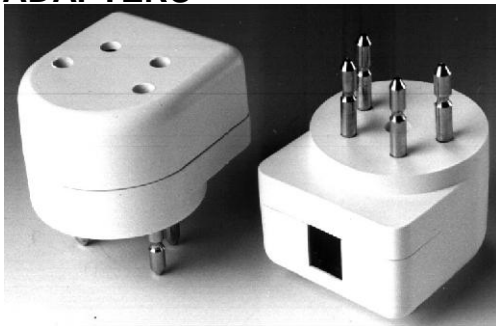

CODE		Dutch jack	Dutch plug	mod.jack RJ 11	protect sleeve
Black	White				
1 AH001	1 AH 101	4 cont.	4 cont.	6/4	—
1 AH011	1 AH111	4 cont.	—	6/4	—

\* Special order ( other colours possible )

### ASSEMBLING DATA

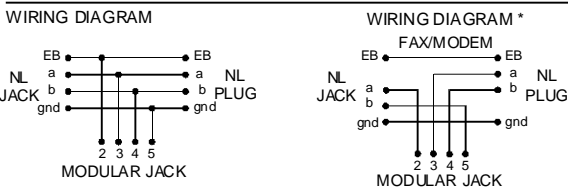
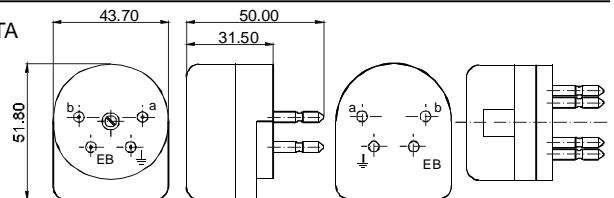

## EXTENSION SOCKET



CODE		Dutch jack	MODULAR JACK		
White	Ivory		RJ 11	RJ 11	RJ 11
1DHAV110	1DHBV110	4 cont.	—	—	—
1DHAV111	1DHBV111	4 cont.	—	6/4	—
1DHAV112	1DHBV112	4 cont.	6/4	—	6/4
1DHAV113	1DHBV113	4 cont.	6/4	6/4	6/4

\* Special order ( other colours possible )

### ASSEMBLING DATA

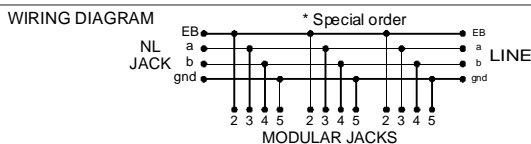
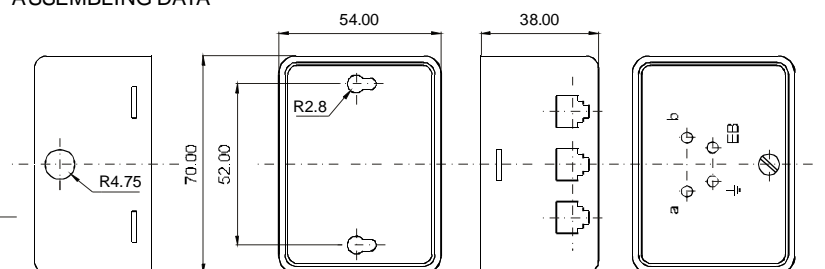



## PLUG

PLUG	DESCRIPTION
1 CF 001	For flat cable (4 cont.)

\* Special order ( other colours possible )



Plug is delivered in unassembled state.

### ASSEMBLING DATA

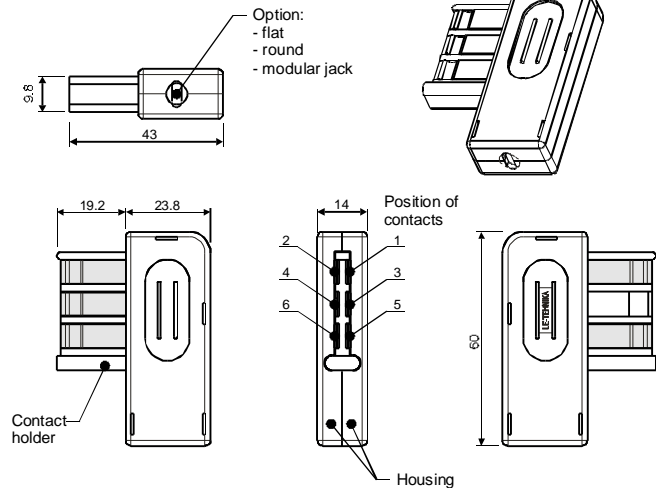

## ADAPTER

ADAPTER	DESCRIPTION
1 AF 009	Modular plug RJ 10 (2 cont.)
1 AF 011	Modular plug RJ 11 (4 cont.)

\* Special order ( other colours possible )



### ASSEMBLING DATA

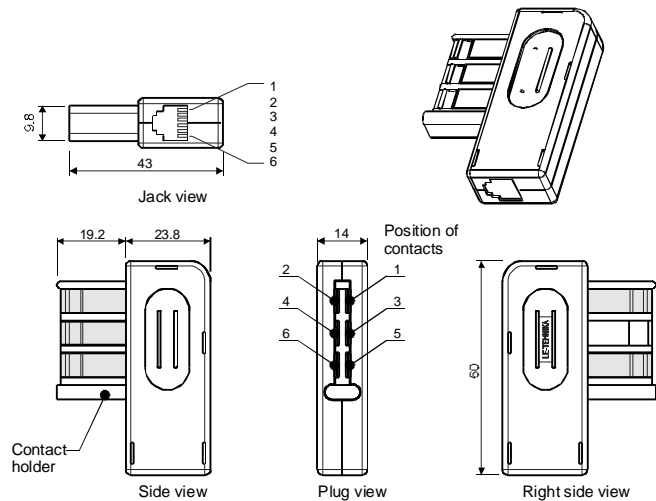

### WIRING DIAGRAM

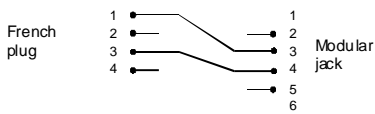

\* Other wirings possible

## FRENCH EXTENSION CORD



### OPTIONS:

- Standard cable colour: Black, White
- Cable length: 0,2 to ... meters
- Typ of cable : flat or round

**BY REQUEST**

### WIRING DIAGRAM

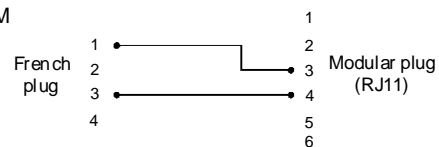

\* Other wiring possible!

## EURO JACK



WIRING DIAGRAM

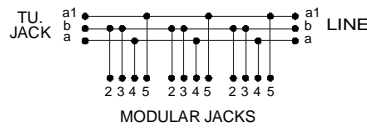

WHITE			MODULAR JACK		
Flash mounting	Surface mounting	Tu. jack	RJ 11	RJ 11	RJ 11
1 DIA 100	1 DIA 110	3 cont.	—	—	—
1 DIA 101	1 DIA 111	3 cont.	—	6/4	—
1 DIA 102	1 DIA 112	3 cont.	6/4	—	6/4
1 DIA 103	1 DIA 113	3 cont.	6/4	6/4	6/4

\* Special order ( other colours possible )

## EXTENSION SOCKET



WIRING DIAGRAM

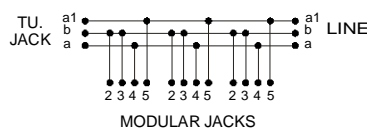

		MODULAR JACK		
Surface mount.	Tu. jack	RJ 11	RJ 11	RJ 11
1 DIAV 110	3 cont.	—	—	—
1 DIAV 111	3 cont.	—	6/4	—
1 DIAV 112	3 cont.	6/4	—	6/4
1 DIAV 113	3 cont.	6/4	6/4	6/4

\* Special order ( other colours possible )

## PLUG, ADAPTER



PLUG

Code Plug 1	Colour	Code Plug 2	Colour
1 CT 001	Black	1 CTN 001	Black
1 CT 101	White	1 CTN 101	White



Plug 1

ADAPTER

Code		Tu. jack	Tu. plug	mod jack RJ 11	protect sleeve	wiring diagram
Black	White					
1 ATN 001	1 ATN 101	3 cont.	3 cont.	1x	—	1
1 ATN 006	1 ATN 106	3 cont.	—	—	yes	1
1 ATN 008	1 ATN 108	3 cont.	—	1x	yes	1
1 ATN 010	1 ATN 110	3 cont.	—	1x	—	1
1 ATN 021	1 ATN 121	3 cont.	3 cont.	1x	—	2
1 ATN 032	1 ATN 132	3 cont.	3 cont.	2x	—	2
1 ATN 032A	1 ATN 132A	—	3 cont.	1x 6/4, 1x 8/4	—	3 - ADSL

Plug 2

WIRING DIAGRAM : 1

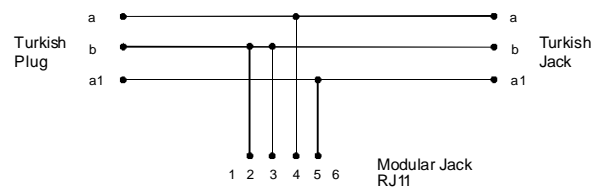

WIRING DIAGRAM : 2

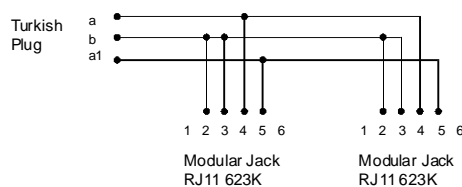

WIRING DIAGRAM : 3 - ADSL

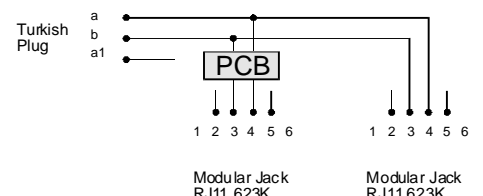

## NORWEGIAN & FINNISH PLUG NORWEGIAN & FINNISH ADAPTER

ADAPTER	Description
1 AFL 009	Fin-Nor. Plug / Modular Jack RJ11 (6/4)
1 AFL 140	Fin-Nor. Plug / Modular Jack 8-6/4
1 AFL 132	Fin-Nor. Plug / 2 x modular Jack RJ11 (6/4)

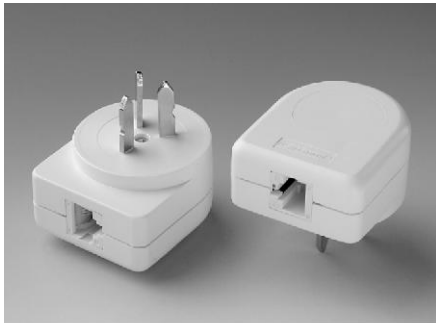

1 AFL 009



1 AFL 132

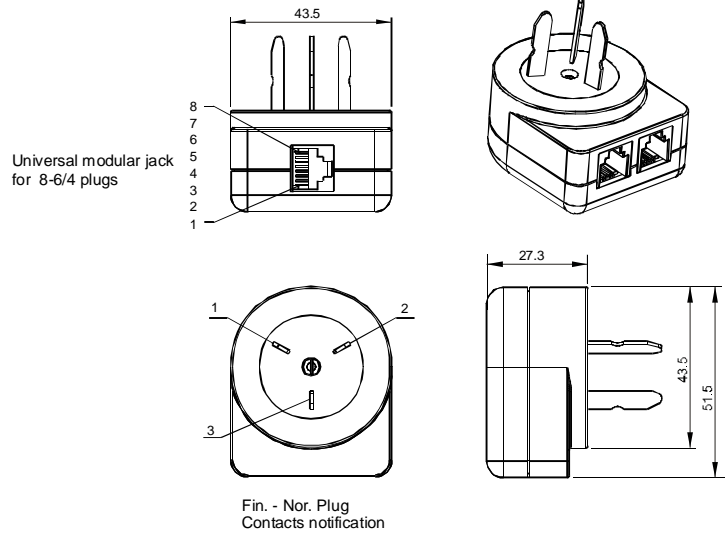

### WIRING DIAGRAM: 1AFL132

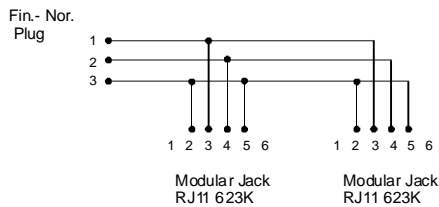

### WIRING DIAGRAM: 1AFL009 or 1AFL140

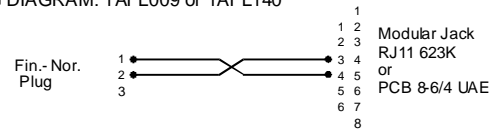

## NORWEGIAN & FINNISH EXTENSION CORD

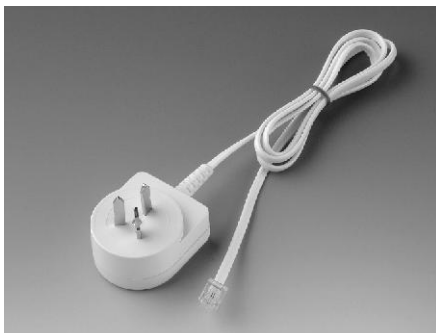

- OPTIONS:
- Standard cable colour: Black, White
  - Cable length: 0,2 to ... meters
  - Typ of cable: flat or round

**BY REQUEST**

### WIRING DIAGRAM

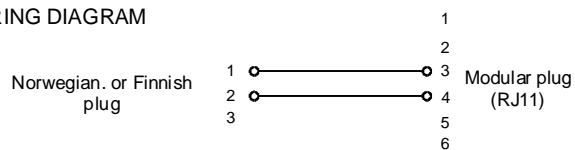

\* Other wiring possible!

## EURO JACK



WHITE		MODULAR JACK			
Flash mount.	Surface mount.	UK JACK	RJ 11	RJ 11	RJ 11
1 DUA200	1 DUA210	2 x	–	–	–
1 DUA201	1 DUA211	2 x	–	6/4	–
1 DUA202	1 DUA212	2 x	6/4	–	6/4
1 DUA203	1 DUA213	2 x	6/4	6/4	6/4

\* Special order ( other colours possible )

### ASSEMBLING DATA

### WIRING DIAGRAM

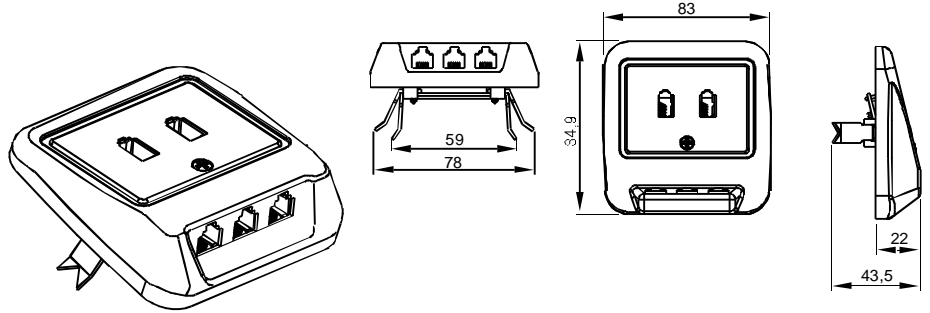
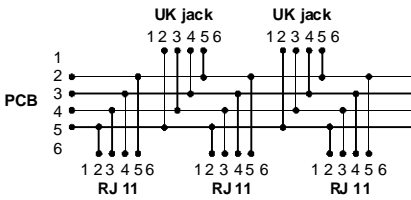

## ADAPTER UK / RJ11

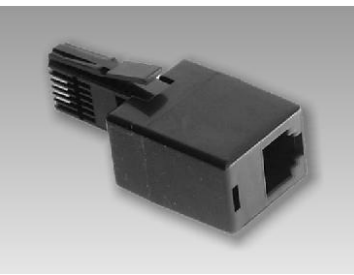

CODE	Color	Number of contacts
1 AUK 009	Black	2
1 AUK 011	Black	4

### ASSEMBLING DATA

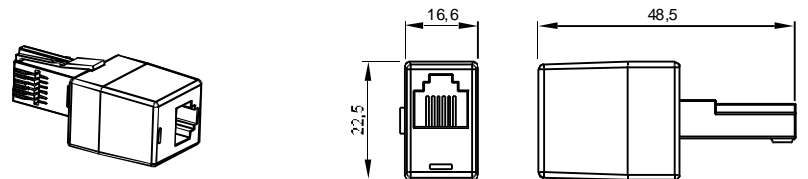

## ADAPTER UK plug / 2x UK Jack



CODE	Number of contacts
1 AUK 124	4
1 AUK 126	6

### ASSEMBLING DATA

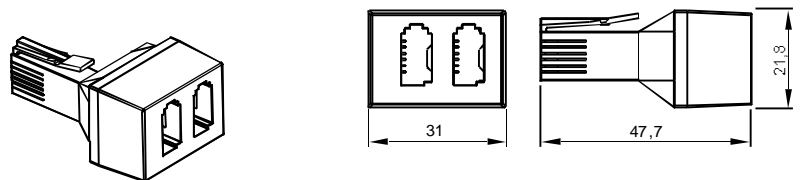

## ADAPTER UK plug / 1x UK jack, 1x RJ 11 jack



CODE	Number of contacts
1 AUK 114	4
1 AUK 116	6

### ASSEMBLING DATA

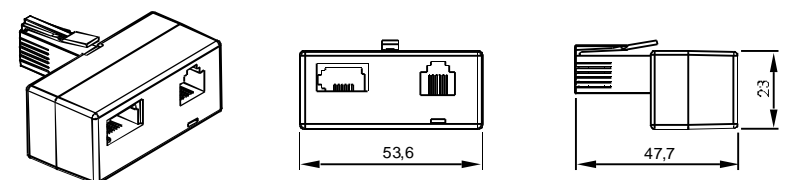

## UK PLUG

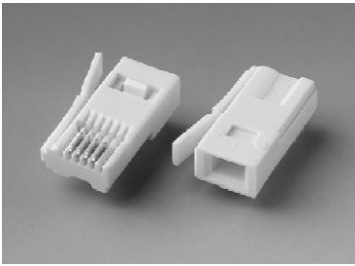

CODE	Number of contacts
2 CB 064	4
2 CB 066	6

### ASSEMBLING DATA

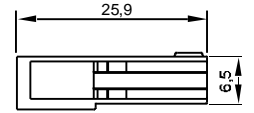
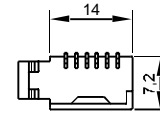

## UK JACK

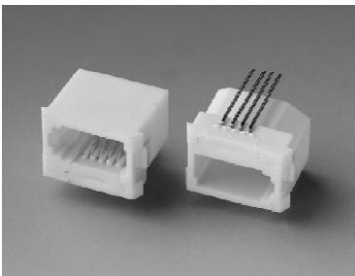

CODE	Number of contacts
2 DHU 064	4
2 DHU 066	6

### ASSEMBLING DATA

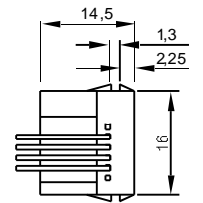
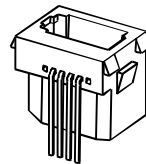

## EXTENSION CORDS



CODE	Number of contacts
1BIS20185S	4

**BY REQUEST**

- OPTIONS:
- Standard cable colour: Black, White
  - Cable length: 0,2 to ... meters
  - Typ of cable : flat or round.

\* Other wiring possible!

### WIRING DIAGRAM

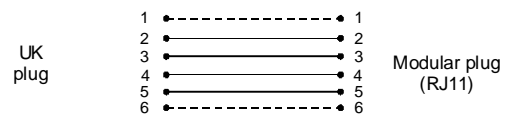

## CUSTOMIZED CORDS



P. 1:

	Code: see page 32 - Unladapter	+	Cable	+	Code: see to p of page and page 05	=	WHOLE CODE:
P. 1:	1Z AA 66 C1 B	+	03	+	UK Plug: 2BC066	=	1Z AA 66 C1 B 03 2BC066
P. 2:	1Z DD AB C1 B	+	03	+	RJ Plug: 2 CA 060	=	1Z DD AB C1 B 03 2CA060



P. 2:

CABLE	STANDARD LENGTHS OF CABLES						
	Type of cable	0,2 m	3 m	5 m	6 m	10 m	15 m
Code	72	03	05	06	10	15	

## UNIVERSAL POWER ADAPTER KIT with Built-In Surge protection

CODE: 1AA 5302

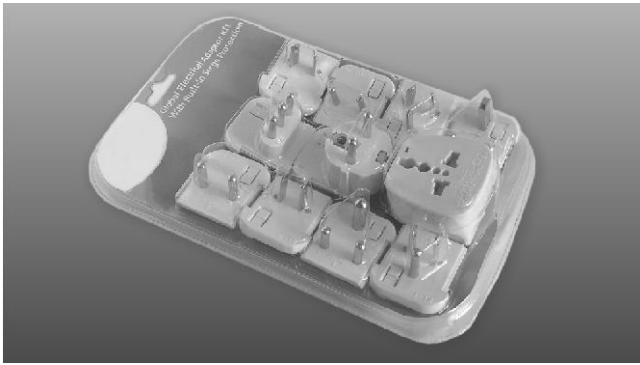

Global Electrical Adapter Kit

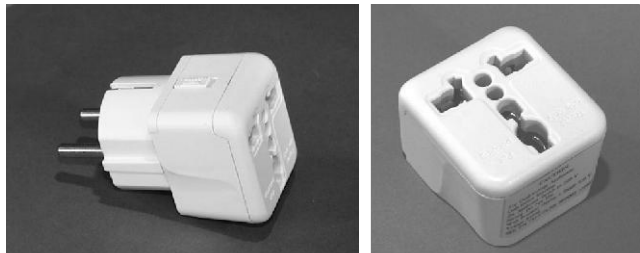

Combined adapter

Base

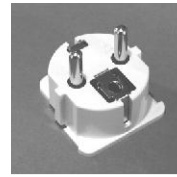

Germany

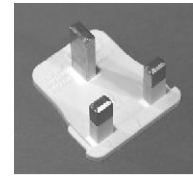

UK

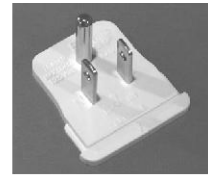

USA



Italy

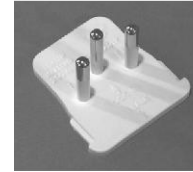

Switzerland



EU



Australia



Taiwan



South Africa

## TRAVEL POWER ADAPTER with prevention of direct touch



CODE: 1AA 511K

**Plug:** Central Europe, Germany  
**Socket:** USA, UK, Australia, Italy, Switzerland, France, Other...

CODE: 1AA 514K

**Plug:** USA  
**Socket:** USA, UK, Australia, Italy, Switzerland, France, Other...

CODE: 1AA 512K

**Plug:** Australia  
**Socket:** USA, UK, Australia, Italy, Switzerland, France, Other...

CODE: 1AA 515K

**Plug:** Switzerland  
**Socket:** USA, UK, Australia, Italy, Switzerland, France, Other...

CODE: 1AA 513K

**Plug:** UK  
**Socket:** USA, UK, Australia, Italy, Switzerland, France, Other...

CODE: 1AA 518K

**Plug:** Central Europe (with grounding)  
**Socket:** USA, UK, Australia, Italy, Switzerland, France, Other...

## TRAWEL CONVERTER - 110/220V - 50W

110 V CODE: 1NA029

220 V CODE: 1NA039



COMPOUND ADAPTER  
110 x 48 x 52 mm



EUROPE  
MIDDLE EAST



UK, HKG,  
SINGAPORE



USA, S. AMERICA  
JAPAN, TAIWAN



AUSTRALIA  
NEW ZEALAND

Notice:

---

---

---

---

---

---

---

---

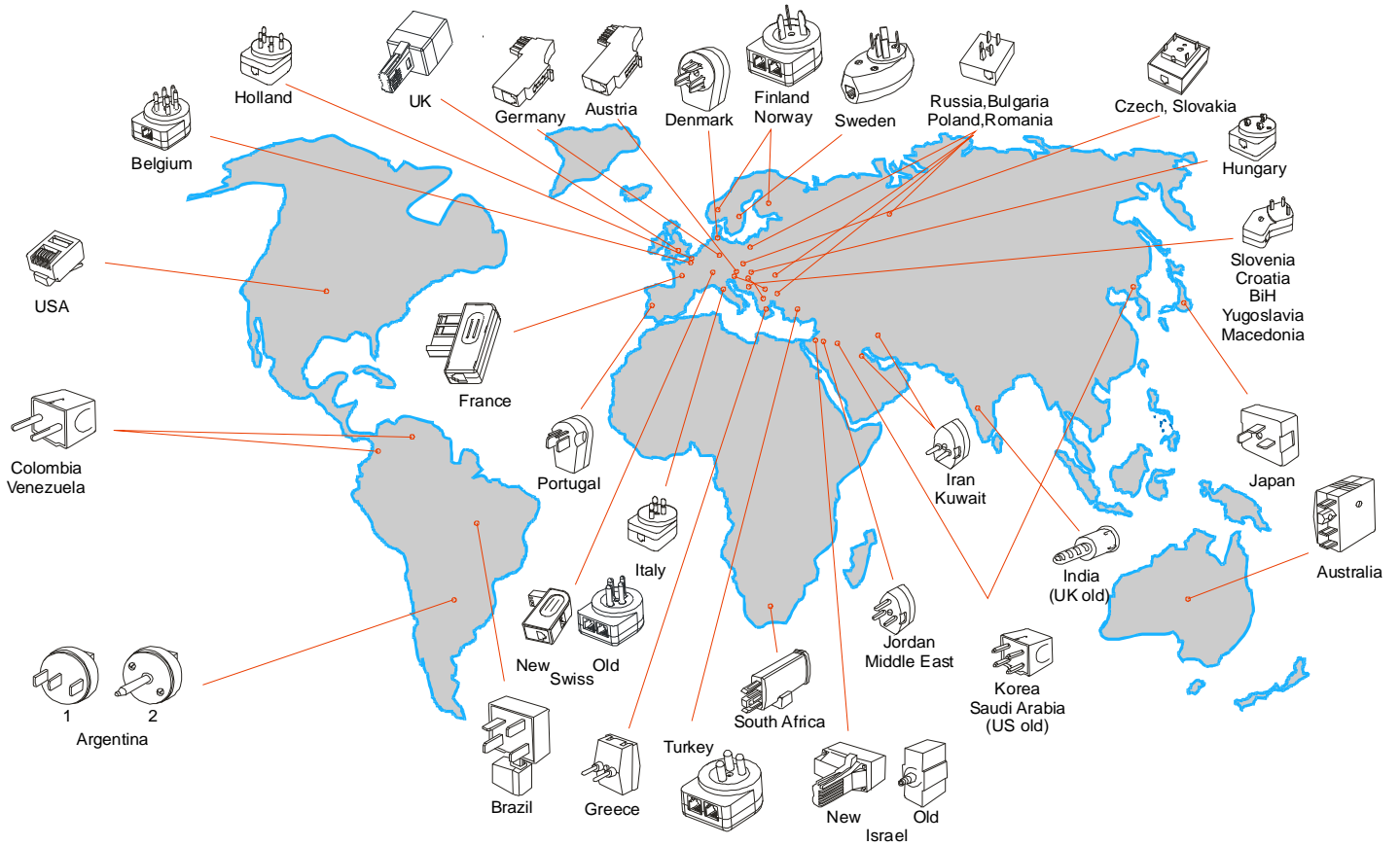

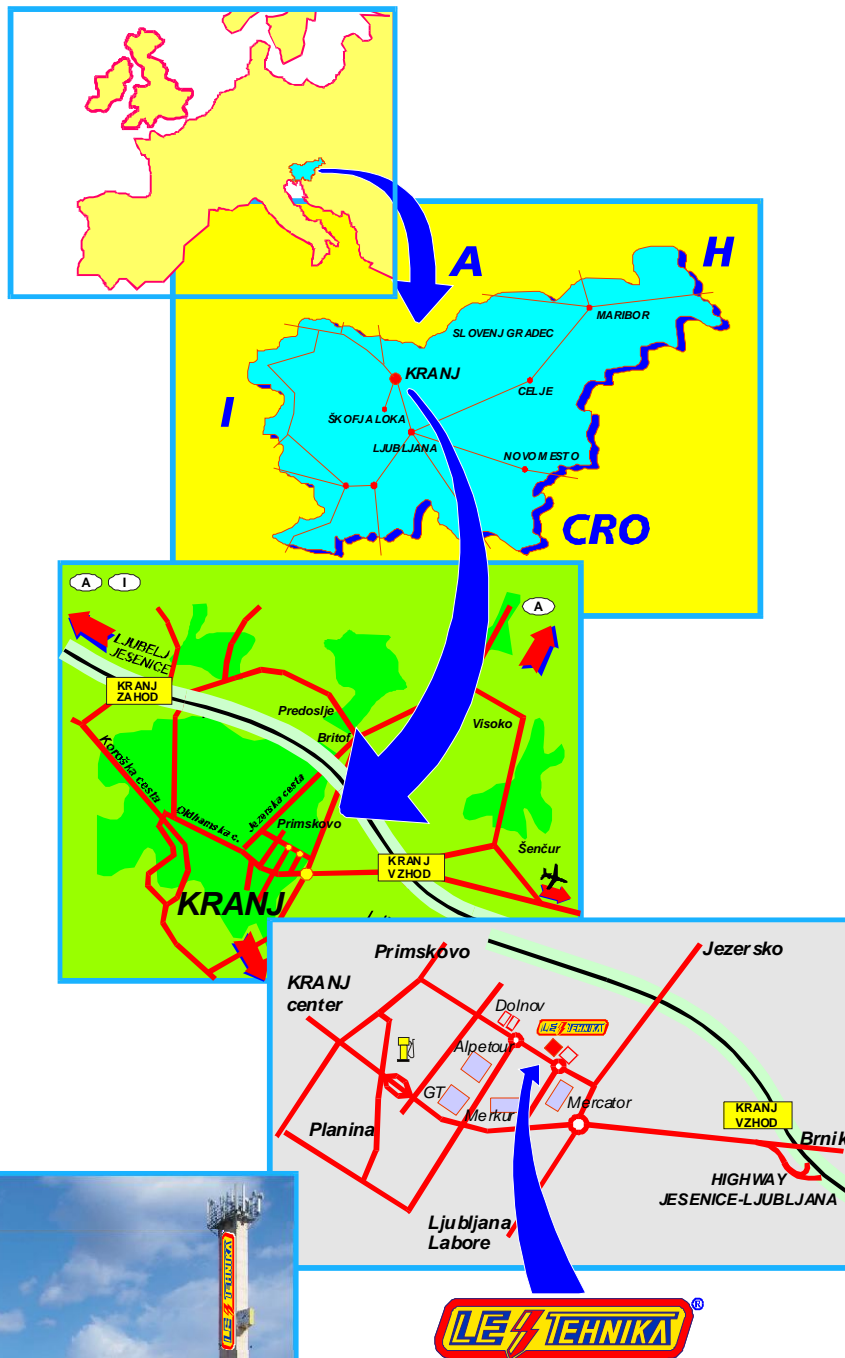

LE-TEHNIKA d.o.o. Šuceva 27, 4000 KRANJ - SLOVENIA  
tel.: +386 4 20 20 200, fax: +386 4 204 21 22  
e-mail: [telephone@le-tehnika.si](mailto:telephone@le-tehnika.si)  
<http://www.le-tehnika.com>